

CYLINDRIC SKEW SCHUR FUNCTIONS

PETER MCNAMARA

ABSTRACT. Cylindric skew Schur functions, which are a generalisation of skew Schur functions, arise naturally in the study of P -partitions. Also, recent work of A. Postnikov shows they have a strong connection with a problem of considerable current interest: that of finding a combinatorial proof of the non-negativity of the 3-point Gromov-Witten invariants. After explaining these motivations, we study cylindric skew Schur functions from the point of view of Schur-positivity. Using a result of I. Gessel and C. Krattenthaler, we generalise a formula of A. Bertram, I. Ciocan-Fontanine and W. Fulton, thus giving an expansion of an arbitrary cylindric skew Schur function in terms of skew Schur functions. While we show that no non-trivial cylindric skew Schur functions are Schur-positive, we conjecture that this can be reconciled using the new concept of cylindric Schur-positivity.

Version of 18th August 2005

1. INTRODUCTION

Cylindric skew Schur functions can be introduced in two very different ways. From a combinatorial perspective, one of these motivations is classical, while the other is more contemporary. The classical motivation begins with R. Stanley's (P, ω) -partitions, and is centred around a long-standing conjecture of Stanley which gives conditions for a generating function for the set of (P, ω) -partitions to be a symmetric function. This will be the subject of Section 2 and we will finish the section by showing how a natural generalisation of (P, ω) -partitions leads to the idea of a cylindric skew Schur function. We will then give a formal definition of cylindric skew shapes and cylindric skew Schur functions in Section 3. At this stage we make the fundamental observations that cylindric skew Schur functions are symmetric functions and that skew Schur functions are themselves cylindric skew Schur functions. Therefore, cylindric skew Schur functions can be viewed as a generalisation of skew Schur functions, and it is logical to ask which properties of skew Schur functions are preserved under this generalisation.

The contemporary motivation for cylindric skew Schur functions involves the quantum cohomology ring of the Grassmannian and the fundamental open problem of finding a combinatorial proof of the non-negativity of the 3-point Gromov-Witten invariants. While it will be our starting point in Section 4, no knowledge of quantum cohomology will be assumed and our emphasis will be combinatorial. Gromov-Witten invariants are connected to the topic of cylindric skew Schur functions via a theorem of A. Postnikov [15]. Since cylindric skew Schur functions are symmetric, they can be expanded in terms of Schur functions and Postnikov's theorem states that the Gromov-Witten invariants appear as particular coefficients in this expansion. The fundamental open problem mentioned above then becomes a question about the Schur-positivity of cylindric skew Schur functions. Rather than

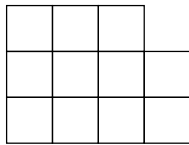
FIGURE 1. The Young diagram for $\lambda = (4, 4, 3)$

addressing the open problem directly, our goal is to give a general study of the Schur-positivity of cylindric skew Schur functions.

The geometric definition of Gromov-Witten invariants tells us that cylindric skew Schur functions in a restricted number of variables are Schur-positive. In Section 5, we show that, except for trivial cases, cylindric skew Schur functions are never Schur-positive in infinitely many variables. Since they play an important role in our proof of this result, we investigate the class of “cylindric ribbons,” determining the form of the Schur expansion of their corresponding cylindric skew Schur functions. We also show that, except for trivial cases, cylindric skew Schur functions are never F -positive, where F denotes the fundamental quasisymmetric functions. We finish Section 5 with a discussion of the minimum number of variables in which a cylindric skew Schur function will not be Schur-positive.

In Section 6, we develop a tool for expanding cylindric skew Schur functions as a signed sum of skew Schur functions. A result of I. Gessel and C. Krattenthaler [7] serves as the foundation for our tool, while our formulation is inspired by a result of A. Bertram, I. Ciocan-Fontanine and W. Fulton [2].

That cylindric skew Schur functions are not Schur-positive is in a sense unfortunate as we would like an extension of the fact that skew Schur functions are Schur-positive. In Section 7, we define cylindric Schur-positivity as a natural generalisation of Schur-positivity and we give evidence in favour of a conjecture that all cylindric skew Schur functions are cylindric Schur-positive.

Before beginning in earnest, we introduce terminology and notation that we will use throughout. We will denote the sets of integers, non-negative integers and positive integers by \mathbb{Z} , \mathbb{N} and \mathbb{P} respectively. We will write $[N]$ to denote the set $\{1, 2, \dots, N\}$. For symmetric function notation, we will follow [10].

A *composition* of N is a sequence $\alpha = (\alpha_1, \dots, \alpha_k)$ of positive integers that sum to N . We write $l(\alpha)$ to denote the number of parts of α . A composition $\lambda = (\lambda_1, \dots, \lambda_k)$ is a *partition* if its sequence of parts is weakly decreasing. We also allow partitions to have parts equal to zero and we identify λ with the sequence $(\lambda_1, \dots, \lambda_k, 0, 0, \dots)$. We write $l(\lambda)$ for the number of non-zero parts (length) of λ and $|\lambda|$ for the sum of the parts of λ . We use a^k in the list of parts of a partition to denote a sequence of k parts of size a . Thus, a partition of the form $(j, 1^k)$ has one part of size j and k parts of size 1. Such partitions are called *hooks*. We let \emptyset denote the unique partition with length 0. We can represent a partition λ by its Young diagram drawn in French notation. For example, Figure 1 shows the diagram of the partition $(4, 4, 3)$. The *conjugate partition* $\lambda' = (\lambda'_1, \lambda'_2, \dots)$ of λ is the partition obtained by reading the column lengths of λ , so in Figure 1, $\lambda' = (3, 3, 3, 2)$.

If μ is another partition then we say that $\mu \subseteq \lambda$ if $\mu_i \leq \lambda_i$ for all i . This is equivalent to saying that the diagram of μ is contained in the diagram of λ . If $\mu \subseteq \lambda$, then we define the *skew shape* λ/μ to be the set of boxes in the diagram of

λ that remain after we remove those boxes corresponding to the partition μ . We denote the number of boxes of λ/μ by $|\lambda/\mu|$. A *ribbon* (or *rim hook* or *border strip*) is an edgewise connected skew shape that contains no 2×2 block of boxes. An *n-ribbon* is then simply a ribbon with n boxes.

If a formal power series f can be written uniquely as a linear combination of some set of basis elements $\{u_i\}_{i \in I}$ with index set I , then we write $[u_i]f$ to denote the coefficient of u_i in this linear combination. We say that f is *u-positive* if $[u_i]f \geq 0$ for all $i \in I$. For example, consider the skew Schur function $s_{\lambda/\mu}(x)$ in the variables $x = (x_1, x_2, \dots)$. (For an implicit definition of the skew Schur function $s_{\lambda/\mu}$, see Example 2.4.) It can be expanded uniquely in terms of Schur functions as

$$s_{\lambda/\mu}(x) = \sum_{\nu} c_{\mu\nu}^{\lambda} s_{\nu}(x),$$

where $c_{\mu\nu}^{\lambda}$ denotes the ubiquitous *Littlewood-Richardson coefficient*. It is well known that Littlewood-Richardson coefficients are non-negative and skew Schur functions are thus one of the most important examples of *Schur-positive* functions. Schur-positivity has a particular representation-theoretic significance: if a homogeneous symmetric function of degree N is Schur-positive, then it is known to arise as the Frobenius image of some representation of the symmetric group S_N . This is one of the reasons why questions of Schur-positivity have received, and continue to receive, much attention in recent times.

ACKNOWLEDGEMENTS

This work was begun while the author was a graduate student at MIT. I am grateful to my advisor, Richard Stanley, and to Alex Postnikov, for several interesting discussions on the topic. François Bergeron and Christophe Reutenauer, my mentors at LaCIM, have both made valuable suggestions, and their expertise and enthusiasm have been of considerable assistance. Finally, I thank the referee for several suggestions that improved the exposition.

2. CYLINDRIC SKEW SCHUR FUNCTIONS FROM (P, ω) PARTITIONS

Let P be a finite partially ordered set (poset) with N elements and let $\omega : P \rightarrow [N]$ be any bijection labelling the elements of P . We will sometimes refer to elements of P by their images under ω . The following definition first appeared in [16].

Definition 2.1. A (P, ω) -partition is a map $\sigma : P \rightarrow \mathbb{P}$ with the following properties:

- (i) If $s < t$ in P then $\sigma(s) \leq \sigma(t)$. i.e. σ is order-preserving.
- (ii) If $s < t$ and $\omega(s) > \omega(t)$ then $\sigma(s) < \sigma(t)$.

Thus a (P, ω) -partition is an order-preserving map from P to the positive integers with additional strictness conditions depending on ω . If $s < t$ is an edge in the Hasse diagram of P and $\omega(s) > \omega(t)$, then we will refer to (s, t) as a *strict* edge. Otherwise, we will say that (s, t) is a *weak* edge. In particular, if ω is itself order-preserving, then all edges are weak and so any order-preserving map from P to \mathbb{P} is a (P, ω) -partition. For more information on (P, ω) -partitions, see [6], [17, §4.5] and [19, §7.19]. We will denote the set of (P, ω) -partitions by $\mathcal{A}(P, \omega)$.

Our initial object of study will be the (P, ω) -partition generating function $K_{P, \omega}(x)$ in the variables $x = (x_1, x_2, \dots)$ defined by

$$K_{P, \omega}(x) = \sum_{\sigma \in \mathcal{A}(P, \omega)} \prod_{t \in P} x_{\sigma(t)} = \sum_{\sigma \in \mathcal{A}(P, \omega)} x_1^{\#\sigma^{-1}(1)} x_2^{\#\sigma^{-1}(2)} \dots$$

We see that $K_{P, \omega}(x)$ is a quasisymmetric function:

Definition 2.2. A *quasisymmetric function* in the variables x_1, x_2, \dots , say with rational coefficients, is a formal power series $f = f(x) \in \mathbb{Q}[[x_1, x_2, \dots]]$ of bounded degree such that for every sequence $n_1, n_2, \dots, n_m \in \mathbb{P}$ of exponents,

$$[x_{i_1}^{n_1} x_{i_2}^{n_2} \dots x_{i_m}^{n_m}] f = [x_{j_1}^{n_1} x_{j_2}^{n_2} \dots x_{j_m}^{n_m}] f$$

whenever $i_1 < i_2 < \dots < i_m$ and $j_1 < j_2 < \dots < j_m$.

Notice that we get the definition of a symmetric function when we change the condition that the sequences i_1, i_2, \dots, i_m and j_1, j_2, \dots, j_m be strictly increasing to the weaker condition that each sequence consists of distinct elements. As an example, the formal power series

$$f(x) = \sum_{1 \leq i < j} x_i^2 x_j$$

is a quasisymmetric function but is not a symmetric function. While they appeared implicitly in earlier work, quasisymmetric functions were first defined by Gessel [6], motivated by the function $K_{P, \omega}(x)$.

There are two bases for quasisymmetric functions that will be useful. If $\alpha = (\alpha_1, \dots, \alpha_k)$ is a composition of N , then we define the *monomial quasisymmetric function* M_α by

$$M_\alpha = \sum_{1 \leq i_1 < \dots < i_k} x_{i_1}^{\alpha_1} \dots x_{i_k}^{\alpha_k}. \quad (2.1)$$

It is clear that the set $\{M_\alpha\}$, where α ranges over all compositions of N , forms a basis for the vector space of quasisymmetric functions that are homogeneous of degree N . We also define the *fundamental quasisymmetric function* F_α by

$$F_\alpha = \sum_{\beta \geq \alpha} M_\beta,$$

where $\beta \geq \alpha$ denotes that β is a composition of N that is a refinement of the composition α . For example, $F_{31} = M_{31} + M_{211} + M_{121} + M_{1111}$. By Inclusion-Exclusion,

$$M_\alpha = \sum_{\beta \geq \alpha} (-1)^{l(\beta) - l(\alpha)} F_\beta.$$

Hence the set $\{F_\alpha\}$, where α ranges over all compositions of N , forms an alternative basis for the vector space of homogeneous quasisymmetric functions of degree N .

We are now ready to give a concrete example of $K_{P, \omega}(x)$.

Example 2.3. Suppose (P, ω) is given by Figure 2, where the double edges correspond to strict edges of P . We see that a (P, ω) -partition σ must fall into exactly one of the classes shown in Table 1. We conclude that

$$K_{P, \omega}(x) = M_{211} + M_{121} + 2M_{1111} = F_{211} + F_{121}.$$

Therefore, the monomial $x_1^2 x_2 x_3$ appears with coefficient 1 in $K_{P, \omega}(x)$ whereas $x_1 x_2 x_3^2$ has coefficient 0. In particular, $K_{P, \omega}(x)$ is not symmetric. In general,

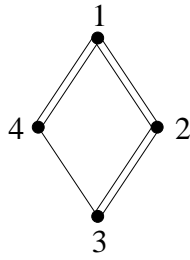

FIGURE 2. A poset P with its labelling ω

Values of σ	Contribution to $K_{P,\omega}(x)$
$\sigma(3) = \sigma(4) < \sigma(2) < \sigma(1)$	M_{211}
$\sigma(3) < \sigma(4) = \sigma(2) < \sigma(1)$	M_{121}
$\sigma(3) < \sigma(4) < \sigma(2) < \sigma(1)$	M_{1111}
$\sigma(3) < \sigma(2) < \sigma(4) < \sigma(1)$	M_{1111}

TABLE 1. (P, ω) -partitions for Figure 2

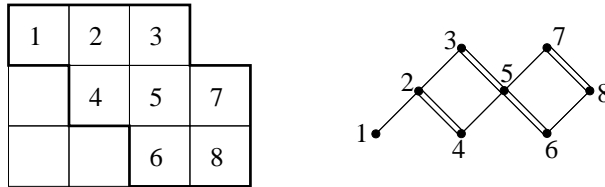

FIGURE 3. A Schur labelled skew shape and its corresponding labelled poset

suppose that we have a quasisymmetric function $f = \sum c_\alpha M_\alpha$, where the sum is over all compositions α of $N \in \mathbb{P}$. We see that f is a symmetric function if and only if $c_\alpha = c_\beta$ whenever α and β are compositions with the same multiset of parts.

Example 2.4. Let λ/μ be a skew shape with $|\lambda/\mu| = N$. We define a *Schur labelling* of λ/μ to be a labelling of the boxes of λ/μ with the numbers $[N]$ that increases down columns and from left to right along rows. Given a Schur labelling ω of λ/μ , let $(P_{\lambda/\mu}, \omega)$ denote the labelled poset suggested by rotating the boxes of λ/μ by 45° counterclockwise. These definitions are best explained by an example and Figure 3 shows a Schur labelling ω of λ/μ and the corresponding labelled poset $(P_{\lambda/\mu}, \omega)$. We say that $(P_{\lambda/\mu}, \omega)$ is a *Schur labelled skew shape poset* or just a *skew shape poset*.

We see that a (P, ω) -partition of a skew shape poset $(P_{\lambda/\mu}, \omega)$ corresponds to an assignment of positive integers to the boxes of λ/μ that weakly increases from left to right along rows and strictly increases up columns. This is exactly the definition of a *semistandard Young tableau* of shape λ/μ . Therefore, the quasisymmetric function $K_{P_{\lambda/\mu}, \omega}$ gives us exactly the *Schur function* $s_{\lambda/\mu}$. We conclude that $K_{P, \omega}(x)$ is symmetric if (P, ω) is a skew shape poset.

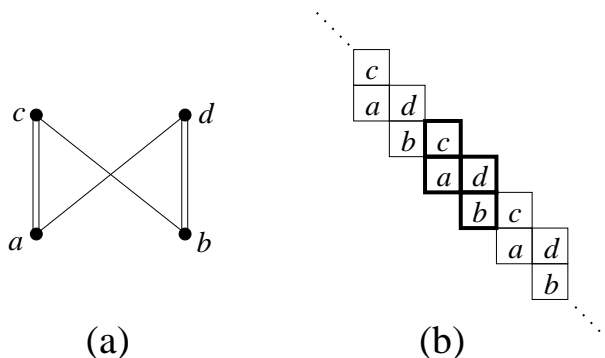

FIGURE 4. An oriented poset and its corresponding cylindric skew shape

This brings us to Stanley’s P -partitions Conjecture [16]. We say that two labelled posets are isomorphic if there exists a poset isomorphism between them that sends weak edges to weak edges and strict edges to strict edges.

Conjecture 2.5. *Let (P, ω) be a labelled poset. $K_{P, \omega}(x)$ is symmetric if and only if (P, ω) is isomorphic to a Schur labelled skew shape poset.*

In [17, Exercise 4.23] and [18], this conjecture is shown to be true when ω is a linear extension. Using [21], we have verified the conjecture for all posets P with $|P| \leq 8$.

The reader may already have observed that to calculate $K_{P, \omega}(x)$, we don’t need to know the full labelling ω . It suffices to know which edges are strict and which edges are weak. Therefore, from now on, we will often omit the labels on the vertices, and when we refer to a “labelled poset,” we mean a poset with strict and weak edges which can come from some underlying labelling.

However, as we shall see, not all designations of strict and weak edges can come from a labelling. Really though, it seems natural that given a poset P , we should allow ourselves to choose any designation O of strict and weak edges. We will then refer to (P, O) as an *oriented poset*, with labelled posets themselves considered to be a special class of oriented posets. For example, consider the oriented poset (P, O) shown in Figure 4(a) and suppose that it actually corresponds to a labelled poset (P, ω) . Then ω would have to satisfy $\omega(a) > \omega(c) > \omega(b) > \omega(d) > \omega(a)$, which is impossible. With this example in mind, given an oriented poset (P, O) , suppose we think of the Hasse diagram of P as a directed graph, with strict edges oriented upwards, and weak edges oriented downwards. We then define a *cycle* of the oriented poset (P, O) to be a cycle in the Hasse diagram of P viewed in this way as a directed graph. So a cycle in an oriented poset can be thought of as a closed path that “goes up” on strict edges and down on weak edges. Note that in a labelled poset, edges will always be oriented towards the smaller label. It follows that if (P, O) is a labelled poset, then it has no cycles. Furthermore, the converse can also be shown to be true: an oriented poset is a labelled poset if it has no cycles.

We define a (P, O) -partition in the obvious manner:

Definition 2.6. Let P be a poset with a designation O of strict and weak edges. A (P, O) -partition is a map $\sigma : P \rightarrow \mathbb{P}$ with the following properties:

- (i) If $s < t$ in P then $\sigma(s) \leq \sigma(t)$. i.e. σ is order-preserving.
- (ii) If $s < t$ and (s, t) is a strict edge, then $\sigma(s) < \sigma(t)$.

As one might expect, we denote the set of (P, O) -partitions by $\mathcal{A}(P, O)$ and we define the generating function $K_{P, O}(x)$ analogously to $K_{P, \omega}(x)$:

$$K_{P, O}(x) = \sum_{\sigma \in \mathcal{A}(P, O)} x_1^{\#\sigma^{-1}(1)} x_2^{\#\sigma^{-1}(2)} \dots$$

Isomorphism of oriented posets is defined exactly as for labelled posets.

Example 2.7. Consider again the oriented poset (P, O) shown in Figure 4(a). Using the same method as in Example 2.3, we can compute that

$$\begin{aligned} K_{P, O}(x) &= M_{22} + 2M_{211} + 2M_{121} + 2M_{112} + 4M_{1111} \\ &= F_{22} + F_{211} + 2F_{121} + F_{112} - F_{1111}. \end{aligned}$$

Since (P, O) is not a labelled poset, it is not considered in Conjecture 2.5. Even so, since $K_{P, O}(x)$ is symmetric, we might wonder if it somehow comes from a skew shape. Referring now to Figure 4(b), we see that we need the box corresponding to a to be directly below the box corresponding to c and directly to the left of the box corresponding to d . Also, we need the box corresponding to b to be directly below the box corresponding to d and directly to the left of the box corresponding to c . Naively putting this all together, we might be led to the construction in Figure 4(b). We refer to such constructions as *cylindric skew shapes* and then $K_{P, O}(x)$ is an example of a *cylindric skew Schur function*. This example motivates the formal definitions of the next section.

3. CYLINDRIC SKEW SCHUR FUNCTIONS

Cylindric skew shapes are not a new idea and there are three references in particular that are of great relevance to our work. The first of these is [7], which will play an important role in Section 6. Semistandard cylindric tableaux, which we will shortly define, appear under the name “proper tableaux” in [2]. The main result of [15] serves as the starting point for our results of the next section. Also, for the following introduction to the notation and definition of cylindric skew shapes, we will largely follow [15].

Fix positive integers u and v . We define the *cylinder* \mathfrak{C}_{vu} to be the following quotient of the integer lattice \mathbb{Z}^2 :

$$\mathfrak{C}_{vu} = \mathbb{Z}^2 / (-u, v)\mathbb{Z}.$$

In other words, \mathfrak{C}_{vu} is the quotient of \mathbb{Z}^2 modulo a shifting action which sends (i, j) to $(i - u, j + v)$. For $(i, j) \in \mathbb{Z}^2$, we let $\langle i, j \rangle = (i, j) + (-u, v)\mathbb{Z}$ denote the corresponding element of \mathfrak{C}_{vu} . \mathfrak{C}_{vu} inherits a natural partial order $\leq_{\mathfrak{C}}$ from \mathbb{Z}^2 which is generated by the relations $\langle i, j \rangle <_{\mathfrak{C}} \langle i + 1, j \rangle$ and $\langle i, j \rangle <_{\mathfrak{C}} \langle i, j + 1 \rangle$.

Note that this partial order is antisymmetric since u and v are positive. Recall that a subposet Q of a poset P is said to be *convex* if, for all elements $x < y < z$ in P , we have $y \in Q$ whenever we have $x, z \in Q$.

Definition 3.1. A *cylindric skew shape* is a finite convex subposet of the poset \mathfrak{C}_{vu} .

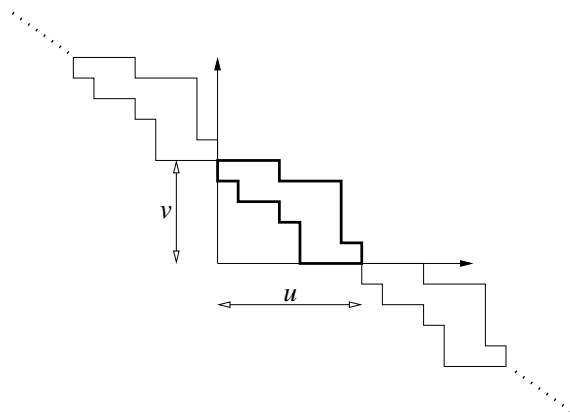

FIGURE 5. Demonstration that skew shapes are cylindric skew shapes

Example 3.2. We can regard skew shapes λ/μ as a special case of cylindric skew shapes. Suppose λ/μ fits inside a box of height v and width u . We embed λ/μ in \mathfrak{C}_{vu} by mapping the box in the i th row and j th column of λ/μ to $\langle i, j \rangle$. Figure 5 shows the resulting image of λ/μ in \mathbb{Z}^2 , with one representative of λ/μ shown in bold. Notice that elements of different representatives of λ/μ are always incomparable in \mathbb{Z}^2 . Of course, we could also embed λ/μ in $\mathfrak{C}_{v'u'}$ where $v' \geq v$ and $u' \geq u$.

Example 3.3. The class of *cylindric ribbons* will play an important role and they are defined in the analogous way to ribbons in the classical case. As we just did for skew shapes, we will identify any cylindric skew shape with its corresponding set of boxes in \mathbb{Z}^2 . Note that the skew shapes from the previous example can be edgewise connected when viewed as subsets of \mathfrak{C}_{vu} . However, they are not edgewise connected when viewed as subsets of \mathbb{Z}^2 , as in the figure.

Definition 3.4. A *cylindric ribbon* is a cylindric skew shape which, when viewed as a subset \mathbb{Z}^2 , is edgewise connected and contains no 2×2 block of boxes.

The cylindric skew shape in Figure 4(b) is an example of a cylindric ribbon.

Suppose C is a cylindric skew shape which is a subposet of the cylinder \mathfrak{C}_{vu} . Let us define what we mean by the rows and columns of C . The p -th row is the set $\{\langle i, j \rangle \in C \mid j = p\}$ and the q -th column is the set $\{\langle i, j \rangle \in C \mid i = q\}$.¹ So the rows only depend on $p \bmod v$ and the columns only depend on $q \bmod u$. Thus the cylinder \mathfrak{C}_{vu} has exactly v rows and u columns.

Definition 3.5. For a cylindric skew shape C , a *semistandard cylindric tableau* of shape C is a map $T : C \rightarrow \mathbb{P}$ that weakly increases in the rows of C and strictly increases in the columns.

See Figure 6(a) for an example. We are now ready to define our main object of study.

¹ In [15], rows and columns are defined the other way around.

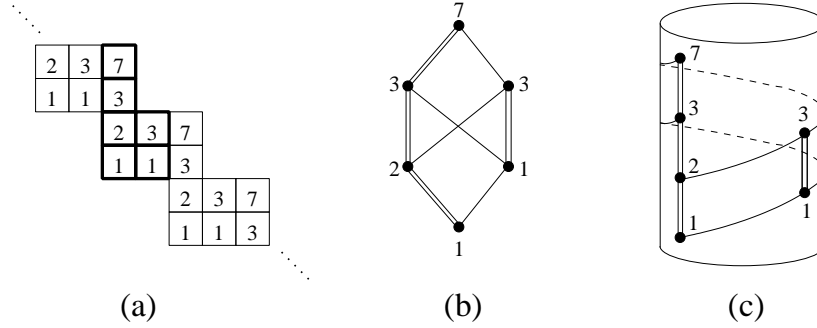

FIGURE 6. A cylindric tableau and its cylindric skew shape poset

Definition 3.6. For a cylindric skew shape C , the *cylindric skew Schur function* $s_C(x)$ in the variables $x = (x_1, x_2, \dots)$ is defined by

$$s_C(x) = \sum_T \prod_{c \in C} x_{T(c)} = \sum_T x_1^{\#T^{-1}(1)} x_2^{\#T^{-1}(2)} \dots,$$

where the sums are over all semistandard cylindric tableaux T of shape C .

The terminology “cylindric skew Schur function” is partially justified by the following two observations:

Example 3.7. Because of Example 3.2, skew Schur functions and, in particular, Schur functions are all examples of cylindric skew Schur functions.

Theorem 3.8. For any cylindric skew shape C , $s_C(x)$ is a symmetric function.

We omit the proof as it is basically the same as the proof from [1], which also appears as [19, Theorem 7.10.2], that the skew Schur function $s_{\lambda/\mu}(x)$ is symmetric.

When C is a cylindric skew shape which is a subposet of the cylinder \mathfrak{C}_{vu} with $u, v \geq 2$, we can give a definition of $s_C(x)$ in terms of (P, O) -partitions. Now the elements of C inherit a partial order from \mathfrak{C}_{vu} . Suppose we consider the vertical edges $\langle i, j \rangle <_{\mathfrak{C}} \langle i, j+1 \rangle$ of C to be strict and the horizontal edges $\langle i, j \rangle <_{\mathfrak{C}} \langle i+1, j \rangle$ to be weak. This designation of strict and weak edges makes C into an oriented poset (P, O) , which we refer to as a *cylindric skew shape poset*. We see that the generating function $K_{P,O}(x)$ then coincides exactly with $s_C(x)$. We will find it convenient to switch to this viewpoint of C and $s_C(x)$ at times.

For example, we encountered a cylindric skew shape poset in Figure 4. Also, because of Example 3.2, skew shape posets are always cylindric skew shape posets. As a further example, Figure 6 shows a semistandard cylindric tableau as well as the corresponding cylindric skew shape poset (P, O) , with elements labelled by their images under the corresponding (P, O) -partition. Figures 5(b) and 5(c) show the same poset, but the intention of Figure 5(c) is to justify the use of the word “cylindric.”

Note 3.9. In the definition above of cylindric skew shape posets, we required that $u, v \geq 2$. This is to ensure that $\langle i, j \rangle <_{\mathfrak{C}} \langle i+1, j \rangle$ and $\langle i, j \rangle <_{\mathfrak{C}} \langle i, j+1 \rangle$ are covering relations. Indeed, suppose that $u = 1$ and $v > 1$. Then we would have

$$\langle 0, 0 \rangle <_{\mathfrak{C}} \langle 0, 1 \rangle <_{\mathfrak{C}} \dots <_{\mathfrak{C}} \langle 0, v \rangle = \langle 1, 0 \rangle$$

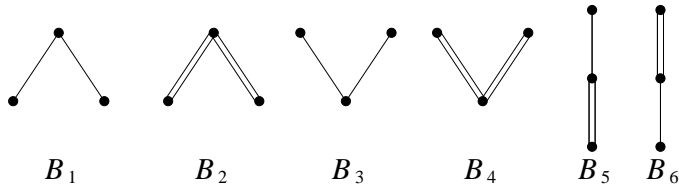

FIGURE 7. The six “forbidden” convex subposets

and so $\langle 0, 0 \rangle$ is not covered by $\langle 1, 0 \rangle$. We have a similar problem if $v = 1$. We will occasionally have a need to consider the cases when u or v is 1, but we will deal with these cases separately.

We wish to conclude this section by mentioning some computations with oriented posets that might affect one’s belief in the truth of Conjecture 2.5. Based on their construction, one could argue that cylindric skew shape posets play the same role for oriented posets as skew shape posets do for labelled posets. In fact, the following two theorems make this analogy even more concrete.

The requirement that (P, ω) be a skew shape poset seems, in effect, to be a global condition on (P, ω) . The following result of C. Malvenuto shows that being a skew shape poset can, in fact, be expressed as a local condition. The proof follows from [11], with some clarification and further analysis of her results in [12]. Consider the six 3-element posets B_1, B_2, \dots, B_6 shown in Figure 7.

Theorem 3.10. *Let (P, ω) be a labelled poset. Then (P, ω) is isomorphic to a skew shape poset if and only if (P, ω) does not contain any B_i as a convex subposet.*

It follows that proving Conjecture 2.5 boils down to showing that if (P, ω) contains a B_i , then $K_{P, \omega}(x)$ is not symmetric. We now state the analogous result for oriented posets. The proof uses several of Malvenuto’s ideas as well as some new ones, and can be found in [14].

Theorem 3.11. *Let (P, O) be an oriented poset. Then every connected component of (P, O) is isomorphic to a cylindric skew shape poset if and only if (P, O) does not contain any B_i as a convex subposet.*

Based on the similarity of these two theorems and other evidence, it is natural to think that the following analogy of Conjecture 2.5 might be true:

Statement 3.12. *Let (P, O) be an oriented poset. $K_{P, O}(x)$ is symmetric if and only if every connected component of (P, O) is isomorphic to a cylindric skew shape poset.*

Because of Theorem 3.11, proving this statement boils down to showing that if (P, O) contains a B_i , then $K_{P, O}(x)$ is not symmetric, just like for Conjecture 2.5. However, Statement 3.12 is false. The smallest counterexamples have 7 elements, and are shown in Figure 8. They were found using [21].

This might cause one to question the validity of Conjecture 2.5. On the other hand, there are other things that are true for labelled posets (P, ω) but not for general oriented posets. For example, $K_{P, \omega}(x)$ has a nice expansion, with all non-negative integer coefficients, in terms of the basis of fundamental quasisymmetric functions F_α . (See [19, Corollary 7.19.5].)

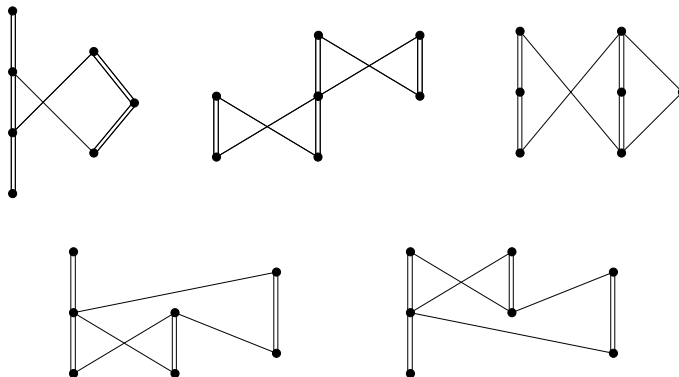

FIGURE 8. Counterexamples to Statement 3.12

4. CYLINDRIC SKEW SCHUR FUNCTIONS FROM GROMOV-WITTEN INVARIANTS

As mentioned previously, there is an entirely different – and relatively new – reason to be interested in cylindric skew Schur functions. This motivation is centred around the main result of [15]. A nice introduction, with emphasis on the context and the importance of Postnikov’s result can be found in [20]. Here, however, we merely extract from these two references the minimum amount of background necessary to show how Postnikov’s work ties together cylindric skew Schur functions and an important open problem in Quantum Schubert Calculus.

Given k and n with $n > k \geq 1$, we let Gr_{kn} denote the manifold of k -dimensional subspaces of \mathbb{C}^n . Gr_{kn} is a complex projective variety known as the *Grassmann variety* or *Grassmannian*. For a partition λ , we will write $\lambda \subseteq k \times (n - k)$ if the Young diagram for λ has at most k rows and at most $n - k$ columns. In this case, we let λ^\vee denote the partition $(n - k - \lambda_k, \dots, n - k - \lambda_1)$. Given $\lambda, \mu, \nu \subseteq k \times (n - k)$, we let $C_{\mu\nu}^{\lambda,d}$ denote the (*3-point*) *Gromov-Witten invariant*, defined geometrically as the number of rational curves of degree d in Gr_{kn} that meet fixed generic translates of the Schubert varieties $\Omega_{\lambda^\vee}, \Omega_\mu$ and Ω_ν , provided that this number is finite. This last condition implies that $C_{\mu\nu}^{\lambda,d}$ is defined if $|\mu| + |\nu| = nd + |\lambda|$, and otherwise we set $C_{\mu\nu}^{\lambda,d} = 0$. If $d = 0$, then a degree 0 curve is just a point in Gr_{kn} and we get the geometric interpretation of the Littlewood-Richardson coefficient $c_{\mu\nu}^\lambda = C_{\mu\nu}^{\lambda,0}$. While we do not claim that this paragraph is sufficient to give a firm understanding of $C_{\mu\nu}^{\lambda,d}$, we do claim that it is clear from this geometric definition that $C_{\mu\nu}^{\lambda,d} \geq 0$. No algebraic or combinatorial proof of this inequality is known and, as stated in [20], it is a fundamental open problem to find such a proof.

Postnikov’s result shows that the Gromov-Witten invariants $C_{\mu\nu}^{\lambda,d}$ appear as the coefficients when we expand certain cylindric skew Schur functions in terms of Schur functions. It follows that improving our understanding of this expansion could lead to a solution of the open problem.

Before stating his result, we need to introduce some notation that will allow us to write any cylindric skew shape in the form $\lambda/d/\mu$, where λ and μ are partitions and where $d \in \mathbb{N}$. From this point on, unless otherwise stated, all of our cylindric skew shapes C will be subsets of the cylinder \mathfrak{C}_{vu} with $v = k$ and $u = n - k$.

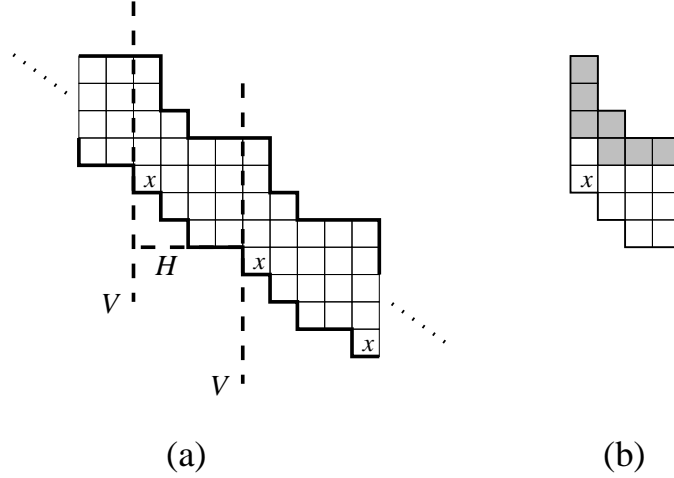
FIGURE 9. Describing C as $\lambda/d/\mu$

Suppose we are given any cylindric skew shape C . The process for finding λ , d and μ is best understood from a figure, and we will use the cylindric skew shape shown in Figure 9(a) as a running example. The boxes labelled x are identified, so that $k = 3$ and $n - k = 4$ in this example. First, we must choose a set of representatives for the elements of C . A convenient way to do this is to take the elements between two adjacent representatives of a vertical line V . Now draw a horizontal line segment H running below each of our representatives of C . In Figure 9(a), we regard the intersection of V and the left end of H as our origin. The partition μ is now the partition whose Young diagram is outlined by H , V and the lower boundary of C . In our example, $\mu = (2, 1)$.

Next, consider just our set of representatives for the elements of C as in Figure 9(b). Define a partition Λ by supposing the resulting skew shape is Λ/μ . Therefore, in our example, $\Lambda = (4, 4, 4, 4, 2, 1, 1)$. If $\Lambda \subseteq k \times (n - k)$ then set $d = 0$, $\lambda = \Lambda$ and we are done. Otherwise, let $\Lambda[-1]$ denote the unique partition ν that makes Λ/ν an n -ribbon with $n - k$ non-empty columns. In other words, $\Lambda[-1]$ is obtained by removing an n -ribbon along the top of Λ , starting in Λ 's leftmost column and ending in Λ 's rightmost column. It is not difficult to see that such a ribbon always has $k + 1$ non-empty rows. In our example, we remove the shaded boxes in Figure 9(b) and $\Lambda[-1] = (4, 4, 4, 1)$. We can see that $\Lambda[-1]$ is well-defined by referring back to Figure 9(a). Effectively what we are doing is removing the cylindric ribbon that runs all the way along the top of C . We see that this cylindric ribbon must have n elements.

Now if $\Lambda[-1] \subseteq k \times (n - k)$, then we set $d = 1$ and $\lambda = \Lambda[-1]$. Otherwise, obtain $\Lambda[-2]$ from $\Lambda[-1]$ in the same way that $\Lambda[-1]$ was obtained from Λ : remove an n -ribbon from the top of $\Lambda[-1]$, starting in the leftmost column and ending in the rightmost column. Repeating this procedure, we can construct $\Lambda[-e]$, stopping as soon as $\Lambda[-e] \subseteq k \times (n - k)$. We then set $d = e$ and $\lambda = \Lambda[-e]$. In our example, we see that $\Lambda[-2] = (3, 3) \subseteq k \times (n - k)$ and so $d = 2$, $\lambda = (3, 3)$ and $\lambda/d/\mu = (3, 3)/2/(2, 1)$.

Remark 4.1. There are several things to note about $\lambda/d/\mu$:

- (i) For a given C , $\lambda/d/\mu$ is clearly not unique and depends on our choice of origin.
- (ii) μ is not necessarily contained in λ . For example, moving our origin 1 square down and 1 square to the left, the reader is encouraged to verify that $\lambda/d/\mu = (3, 3)/3/(4, 3, 2, 1)$. This is an example of the following more general statement. Suppose we have a cylindric shape $\lambda/d/\mu$ with $d \geq 1$ and μ is a partition for which $\mu[-1]$ exists. Then $\lambda/d/\mu$ is the same cylindric shape as $\lambda/(d-1)/\mu[-1]$.
- (iii) We always have $\lambda \subseteq k \times (n-k)$ and it is always possible to choose our origin so that $\mu \subseteq k \times (n-k)$.
- (iv) If $\tau = \mu$, Λ or $\Lambda[-i]$ for $1 \leq i \leq e$, then τ satisfies

$$\tau'_1 \geq \tau'_2 \geq \cdots \geq \tau'_{n-k} \geq \tau'_1 - k.$$

- (v) We could alternatively have defined λ by saying it is the n -core of Λ , where the n -core is defined in the following manner. Given a partition τ , successively remove n -ribbons from τ so that after each ribbon removal, the resulting shape is a partition. Stop when no more n -ribbons can be removed. It is a well-known fact (see, for example, [10, I.1, Example 8]) that the resulting partition λ is independent of the choice of ribbons removed, and λ is said to be the n -core of τ .
- (vi) Our notation $\lambda/d/\mu$ is equivalent to that in [15], but our explanation of it is very different. We choose this description in terms of removal of ribbons because it will be useful in later sections.

For any formal power series f in the variables $x = (x_1, x_2, \dots)$, we will write $f(x_1, \dots, x_k)$ to denote the specialization $f(x_1, x_2, \dots, x_k, 0, 0, \dots)$. We are finally ready to state [15, Theorem 6.3].

Theorem 4.2. *For any two partitions $\lambda, \mu \subseteq k \times (n-k)$ and a non-negative integer d , we have*

$$s_{\lambda/d/\mu}(x_1, \dots, x_k) = \sum_{\nu \subseteq k \times (n-k)} C_{\mu\nu}^{\lambda, d} s_{\nu}(x_1, \dots, x_k). \quad (4.1)$$

Since we are restricting to k variables, the left-hand side is a sum over semistandard cylindric tableaux T that map $\lambda/d/\mu$ to the set $[k]$. Since T must increase in the columns of $\lambda/d/\mu$, this implies that $s_{\lambda/d/\mu}(x_1, x_2, \dots, x_k)$ is non-zero only if all the columns of $\lambda/d/\mu$ contain at most k elements. One can check that this is equivalent to all the rows of $\lambda/d/\mu$ containing at most $n-k$ elements. In this case, we follow Postnikov in saying that $\lambda/d/\mu$ is a *toric* shape. While we take this opportunity to note that toric shapes are the shapes that are most relevant to the Gromov-Witten invariants, we will continue to work with general cylindric skew shapes.

While we will be mostly interested in the case of infinitely many variables $x = (x_1, x_2, \dots)$, we make a few quick remarks about both $s_{\lambda/d/\mu}(x)$ and $s_{\lambda/d/\mu}(x_1, \dots, x_k)$. First, since all the entries in any column of a semistandard cylindric tableau are distinct, the monomial $x_1^{a_1} x_2^{a_2} \cdots$ appears with coefficient 0 in $s_{\lambda/d/\mu}(x)$ if $a_i > n-k$ for some i . This gives the useful fact that

$$s_{\lambda/d/\mu}(x) = \sum_{\nu} c_{\nu} s_{\nu}(x) = \sum_{\nu: \nu_1 \leq n-k} c_{\nu} s_{\nu}(x). \quad (4.2)$$

From this, we conclude

$$s_{\lambda/d/\mu}(x_1, \dots, x_k) = \sum_{\nu: l(\nu) \leq k} c_\nu s_\nu(x_1, \dots, x_k) = \sum_{\nu \subseteq k \times (n-k)} c_\nu s_\nu(x_1, \dots, x_k),$$

explaining why the sum in (4.1) is only over $\nu \subseteq k \times (n-k)$. Finally, we note that $s_{\lambda/d/\mu}(x_1, \dots, x_k)$ is essentially obtained from $s_{\lambda/d/\mu}(x)$ by removing all those terms involving s_ν with $l(\nu) > k$. In fact, in the sections that follow, we will be focusing most of our attention on these terms s_ν with $l(\nu) > k$.

Since we know from the geometric definition of Gromov-Witten invariants that $C_{\mu\nu}^{\lambda,d} \geq 0$, we conclude that $s_{\lambda/d/\mu}(x_1, \dots, x_k)$ is Schur-positive. On the other hand, we observe that $s_{\lambda/d/\mu}(x)$ may not be Schur-positive. For example, the cylindric skew shape C from Example 2.7 has

$$s_C = m_{22} + 2m_{211} + 4m_{1111} = s_{22} + s_{211} - s_{1111}.$$

In the next section, we answer the following question:

Question 4.3. *For what cylindric skew shapes C is $s_C(x)$ Schur-positive?*

5. SCHUR-POSITIVITY

Recall that, unless otherwise stated, all of our cylindric skew shapes C will be subposets of the cylinder $\mathfrak{C}_{k,n-k}$. We saw in Example 3.2 that the skew shape λ/μ can be regarded as a cylindric skew shape C when λ/μ fits inside a box of height k and width $n-k$. In this case, we then know that s_C is Schur-positive. The following theorem, which is the main result of this section, states that these are the only Schur-positive cylindric skew Schur functions. Recall that every cylindric skew shape can be viewed as an oriented poset, and it will be convenient to use this viewpoint for the first half of this section. We will say that two cylindric skew shapes are isomorphic if their corresponding oriented posets are isomorphic.

Theorem 5.1. *Let C be a cylindric skew shape. Then $s_C(x)$ is Schur-positive if and only if C is isomorphic to a skew shape.*

In other words, s_C is never Schur-positive except in the trivial case of C being a skew shape. As we will see in Theorem 5.7, the same result applies with ‘‘Schur-positive’’ replaced by ‘‘ F -positive.’’

Before proving Theorem 5.1, we consider the Schur expansion of cylindric ribbons. While this example is interesting itself, it will also play a key role in the proof of Theorem 5.1. We will identify the cylindric ribbon C with its corresponding oriented poset (P, O) , enabling us to talk about weak and strict ‘‘edges’’ of C . In particular, C must have n elements, k strict edges, and $n-k$ weak edges. We begin with a special class of cylindric ribbons.

Example 5.2. A cylindric ribbon is said to be a *cylindric hook* if it has a unique minimal element (when viewed as an oriented poset). See Figure 10 for an example. We see that, unlike hooks in the classical case, cylindric hooks have just one maximal element. Also note that $\mathfrak{C}_{k,n-k}$ has just one cylindric hook as a subposet, up to isomorphism. We denote this cylindric hook by $H_{k,n-k}$. Cylindric hooks are the simplest example of a cylindric skew shape that is not toric. It follows that $s_{H_{k,n-k}}(x_1, \dots, x_k) = 0$. This is also evident in the following result which shows that the Schur expansion of $s_{H_{k,n-k}}(x)$ is a nice alternating sum of Schur functions of hooks.

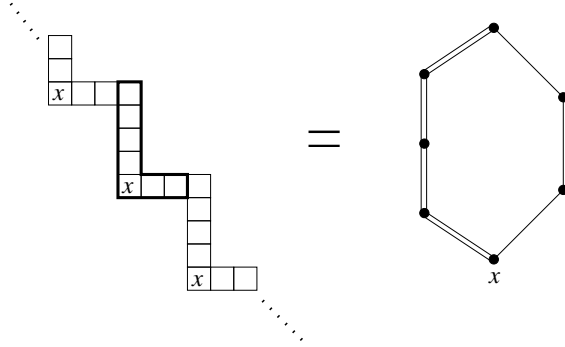

FIGURE 10. The cylindric hook $H_{4,3}$

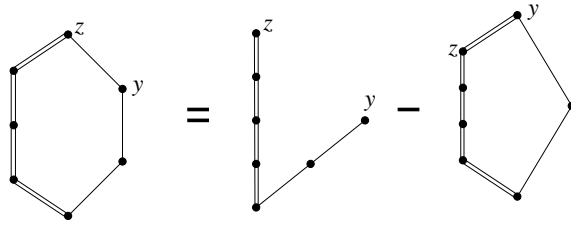

FIGURE 11. A demonstration of the deletion-minus-reversal rule

Lemma 5.3. *With all functions in the variables $x = (x_1, x_2, \dots)$, we have*

$$s_{H_{k,n-k}} = s_{(n-k, 1^k)} - s_{(n-k-1, 1^{k+1})} + \dots + (-1)^{n-k-2} s_{(2, 1^{n-2})} + (-1)^{n-k-1} s_{(1^n)}.$$

We will be ready to prove this lemma as soon as we have introduced a basic tool that will be important for dealing with cylindric ribbons. Suppose (P, O) is an oriented poset with two incomparable elements y and z . In a (P, O) -partition f , either $f(y) \leq f(z)$ or $f(z) < f(y)$. Let $P(y \leq z)$ denote the oriented poset obtained from (P, O) by inserting a weak edge from y up to z , and let $P(z < y)$ denote the oriented poset obtained from (P, O) by inserting a strict edge from z up to y . Finally, let us write $P(y \parallel z)$ for the oriented poset (P, O) . We therefore have

$$K_{P(y \parallel z)}(x) = K_{P(y \leq z)}(x) + K_{P(z < y)}(x). \tag{5.1}$$

For the sake of legibility, we will sometimes write or draw (P, O) in place of $K_{P, O}(x)$ so that (5.1) becomes

$$P(y \parallel z) = P(y \leq z) + P(z < y).$$

The pair of equations below then follow, and we will refer to them as the “deletion-minus-reversal rule”:

$$\begin{aligned} P(y \leq z) &= P(y \parallel z) - P(z < y), \\ P(z < y) &= P(y \parallel z) - P(y \leq z). \end{aligned} \tag{5.2}$$

To see this rule in action, see Figure 11. We pick the weak edge (y, z) in the leftmost poset $P(y \leq z)$ as shown. Deleting this edge, we get the middle oriented poset $P(y \parallel z)$. Reversing the edge and making it strict gives the oriented poset

$P(z < y)$ on the right. The deletion-minus-reversal rule gives an equation among the generating functions, as represented in the figure. In this particular case, we get $H_{4,3} = (3, 1^4) - H_{5,2}$.

Proof of Lemma 5.3. With n fixed, we prove the result by induction on $n - k$, the number of weak edges of $H_{k,n-k}$.

$H_{n-1,1}$ consists of a chain of n elements with $n - 1$ strict edges. (The weak edge that goes from the bottom element to the top element is redundant and hence is discarded. Compare this with Note 3.9.) Therefore, $s_{H_{n-1,1}} = s_{(1^n)}$, as required.

By the deletion-minus-reversal rule applied to the uppermost weak edge of $H_{k,n-k}$, we get that

$$H_{k,n-k} = (n - k, 1^k) - H_{k+1,n-k-1}, \quad (5.3)$$

and the result follows. \square

Remark 5.4. We saw in the above proof that $H_{n-1,1}$, which is a cylindric ribbon, has a Schur-positive generating function $s_{H_{n-1,1}} = s_{(1^n)}$. This is, however, not a contradiction with Theorem 5.1, since $H_{n-1,1}$ is isomorphic to the skew shape (1^n) .

We are now ready to discuss the Schur expansions of general cylindric ribbons.

Proposition 5.5. *Let C be a cylindric ribbon which is a subset of the cylinder $\mathfrak{C}_{k,n-k}$. Then*

$$s_C(x) = \left(\sum_{\nu \subseteq k \times (n-k)} c_\nu s_\nu(x) \right) + s_{H_{k,n-k}}(x),$$

with c_ν a non-negative integer for all $\nu \subseteq k \times (n - k)$.

Proof. From (4.2), we know that

$$s_C(x) = \sum_{\nu \subseteq k \times (n-k)} c_\nu s_\nu(x) + \sum_{\substack{\nu: \nu_1 \leq n-k \\ l(\nu) > k}} c_\nu s_\nu(x).$$

Restricting to k variables eliminates the second sum, and applying Theorem 4.2 then gives that c_ν is a non-negative integer for $\nu \subseteq k \times (n - k)$.

It remains to show that the terms s_ν in the Schur expansion of s_C that have $l(\nu) > k$ correspond to the Schur expansion of $s_{H_{k,n-k}}$. With n considered fixed, we proceed by induction on k , the number of strict edges of C . Like in the previous proof, the base case is somewhat anomalous. If $k = 1$, then C is already the cylindric hook $H_{1,n-1}$ and we are done. While $H_{1,n-1}$ cannot be expressed as an oriented poset, this does not affect the rest of the proof. (Again, compare with Note 3.9.)

For $k > 1$, we pick a strict edge of C and apply the deletion-minus-reversal rule to it. We get that

$$s_C(x) = s_{\lambda/\mu}(x) - s_D(x),$$

where λ/μ is a (classical) ribbon with $k - 1$ strict edges, and D is a cylindric ribbon with $k - 1$ strict edges and $n - k + 1$ weak edges. Applying the induction hypothesis,

we have

$$\begin{aligned} s_C(x) &= s_{\lambda/\mu}(x) - \left(\sum_{\nu \subseteq (k-1) \times (n-k+1)} d_\nu s_\nu(x) \right) - s_{H_{k-1, n-k+1}}(x) \\ &= s_{\lambda/\mu}(x) - \left(\sum_{\nu \subseteq (k-1) \times (n-k+1)} d_\nu s_\nu(x) \right) - s_{(n-k+1, 1^{k-1})}(x) + s_{H_{k, n-k}}(x) \end{aligned}$$

with the second equality coming from (5.3). Since λ/μ has $k-1$ strict edges, it has k rows. Therefore, any term s_ν in its Schur expansion has at most k rows. We conclude that the terms s_ν in the Schur expansion of s_C that have $l(\nu) > k$ are exactly the terms from the expansion of $s_{H_{k, n-k}}(x)$, as required. \square

Remark 5.6. Given that Schur functions are those skew Schur functions that come from skew shapes with a unique minimal element, let us say that *cylindric Schur functions* are those cylindric skew Schur functions that come from cylindric skew shapes with a unique minimal element. Now let C be a cylindric ribbon which is a subposet of $\mathfrak{C}_{k, n-k}$. Theorem 5.1 tells us that $s_C(x)$ is not Schur-positive. However, Proposition 5.5 says that $s_C(x)$ can be expanded as a positive integer linear combination of cylindric Schur functions. Each of these cylindric Schur functions comes from a cylindric skew shape that is also a subposet of $\mathfrak{C}_{k, n-k}$. In this case, let us say that s_C is *cylindric Schur-positive*. Cylindric Schur-positivity will be the subject of Section 7.

For our proof of Theorem 5.1, it will be helpful to follow [12, 13] in defining a coproduct for the ring $QSym$ of quasisymmetric functions. Let \mathbb{P}' denote the set $\{1', 2', \dots\}$ with the total order $1' < 2' < \dots$. Totally order the disjoint union $\mathbb{P} \cup \mathbb{P}'$ by setting $i < j'$ for all $i \in \mathbb{P}, j' \in \mathbb{P}'$. Given a labelled poset (P, ω) , suppose we consider (P, ω) -partitions σ that are maps from P to $\mathbb{P} \cup \mathbb{P}'$, rather than from P to \mathbb{P} . Letting y denote the set of variables $y = (y_1, y_2, \dots)$, we can then set

$$K_{P, \omega}(x, y) = \sum_{\sigma \in \mathcal{A}(P, \omega)} x_1^{\#\sigma^{-1}(1)} x_2^{\#\sigma^{-1}(2)} \dots y_1^{\#\sigma^{-1}(1')} y_2^{\#\sigma^{-1}(2')} \dots$$

Suppose $\alpha = (\alpha_1, \dots, \alpha_k)$ is a composition of N . It is not difficult to find a labelled poset (P, ω) such that $K_{P, \omega}(x) = F_\alpha(x)$. Indeed, we let P be a chain of elements $p_1 < p_2 < \dots < p_N$. Letting $A_i = \sum_{j=1}^i \alpha_j$, we choose ω so that the edge from p_{A_i} to $p_{A_{i+1}}$ is strict for $i = 1, \dots, k-1$, while all other edges are weak. For compositions $\delta = (\delta_1, \dots, \delta_d)$ and $\epsilon = (\epsilon_1, \dots, \epsilon_e)$ we let $\delta\epsilon$ denote the concatenation $(\delta_1, \dots, \delta_d, \epsilon_1, \dots, \epsilon_e)$, while $\delta \circ \epsilon$ will denote the overlap $(\delta_1, \dots, \delta_{d-1}, \delta_d + \epsilon_1, \epsilon_2, \dots, \epsilon_e)$. We can check that

$$F_\alpha(x, y) = \sum_{\delta, \epsilon: \delta\epsilon = \alpha} F_\delta(x) F_\epsilon(y) + \sum_{\delta, \epsilon: \delta \circ \epsilon = \alpha} F_\delta(x) F_\epsilon(y). \quad (5.4)$$

Since the set $\{F_\alpha\}$ forms a basis for $QSym$, it follows that for every quasisymmetric function $G(x, y)$, we can express $G(x, y)$ as a finite sum

$$G(x, y) = \sum_i G_i(x) G'_i(y),$$

where G_i and G'_i are themselves quasisymmetric. This allows us to define the *outer coproduct* $\gamma : QSym \rightarrow QSym \otimes QSym$ by

$$\gamma(G) = \sum_i G_i \otimes G'_i.$$

If (P, O) is an oriented poset and Q is a convex subposet of P , we denote the designation O restricted to the edges of Q by $O|_Q$. It follows from our definition of γ that

$$\gamma(K_{P,O}) = \sum K_{I,O|_I} \otimes K_{J,O|_J} \quad (5.5)$$

where the sum is over all disjoint unions $I \cup J$ such that I is an order ideal of P and J is an order filter (i.e. dual order ideal) of P . In particular,

$$\gamma(s_\lambda) = \sum_{\mu \subseteq \lambda} s_\mu \otimes s_{\lambda/\mu}. \quad (5.6)$$

Thus the outer coproduct for $QSym$ is just an extension of the outer coproduct for symmetric functions of [5, 22, 24]. As one might expect, we say that a coproduct is Schur-positive (resp. F -positive) if it can be written as linear combination of terms of the form $s_\mu \otimes s_\nu$ (resp. $F_\alpha \otimes F_\beta$) with all coefficients positive.

Proof of Theorem 5.1. Suppose C is a cylindric skew shape that is a subposet of the cylinder $\mathfrak{C}_{k,n-k}$. If C is isomorphic to a skew shape, then we know by the Littlewood-Richardson rule that $s_C(x)$ is Schur-positive. Now suppose that C is a cylindric skew shape that is not isomorphic to a skew shape. We note that if $n - k = 1$, then C is isomorphic to a skew shape, so we assume that $n - k \geq 2$. We see from (5.6) that the coproduct of a Schur-positive function is Schur-positive. Our approach will be to show that $\gamma(s_C)$ is not Schur-positive and, therefore, it will follow that $s_C(x)$ is not Schur-positive.

Since C is not isomorphic to a skew shape, C contains a cylindric ribbon. Let R denote the cylindric ribbon with n elements that runs all the way along the top of C and let $C[-1]$ denote the cylindric skew shape that remains after we remove R from C . Clearly, viewing C as an oriented poset, the elements of $C[-1]$ correspond to an order ideal of C and the elements of R correspond to an order filter of C . Choose any partition λ such that s_λ appears with non-zero coefficient m in $s_{C[-1]}$. By Proposition 5.5 and Lemma 5.3, we know that

$$[s_{(1^n)}]s_R = (-1)^{n-k-1} = -[s_{(2,1^{n-2})}]s_R.$$

We will now show that

$$[s_\lambda \otimes s_{(1^n)}]\gamma(s_C) = (-1)^{n-k-1}m = -[s_\lambda \otimes s_{(2,1^{n-2})}]\gamma(s_C), \quad (5.7)$$

implying that $\gamma(s_C)$ cannot be Schur-positive. Indeed, suppose $J \neq R$ is an order filter of C with n elements. The only order filter of C with n elements that contains a cylindric ribbon is R . Therefore, J does not contain a cylindric ribbon and so is isomorphic to a skew shape. However, any skew shape that is a subposet of C has at most k rows. Since $k \leq n - 2$, we conclude that $[s_{(1^n)}]s_J = [s_{(2,1^{n-2})}]s_J = 0$. Applying (5.5), we now deduce (5.7). \square

We should justify our earlier assertion that the following result is also true:

Theorem 5.7. *Let C be a cylindric skew shape. Then $s_C(x)$ is F -positive if and only if C is isomorphic to a skew shape.*

Proof. Our proof is largely the same as the proof of Theorem 5.1. As is known (see, e.g., [19, Theorem 7.19.7]), Schur functions have non-negative coefficients when expressed in the basis of fundamental quasisymmetric functions F_α . More specifically, we define a *standard Young tableau* (SYT) T of shape λ to be a filling of the Young diagram of λ with distinct entries from the set $\{1, 2, \dots, |\lambda|\}$ that increases in the rows and up the columns (using French notation). The descent set of T is defined to be those numbers $i \in \{1, \dots, |\lambda| - 1\}$ such that $i + 1$ is in a strictly higher row of T than i . The composition $co(T)$ is then given by $(i_1, i_2 - i_1, \dots, i_k - i_{k-1}, |\lambda| - i_k)$, where $\{i_1, \dots, i_k\}$ is the descent set of T . We then have

$$s_\lambda = \sum_T F_{co(T)}, \quad (5.8)$$

where the sum is over all SYT T of shape λ .

In particular, we see that $[F_{(1^n)}]s_\lambda = 0$ unless $\lambda = (1^n)$, and $[F_{(2, 1^{n-2})}]s_\lambda = 0$ unless $\lambda = (2, 1^{n-2})$. From Proposition 5.5 and Lemma 5.3, it follows that

$$[F_{(1^n)}]s_R = (-1)^{n-k-1} = -[F_{(2, 1^{n-2})}]s_R,$$

where R is a cylindric ribbon. We now mimic the proof of Theorem 5.1 to show that $\gamma(s_C)$ is not F -positive. However, by (5.4), the coproduct of an F -positive function is F -positive, so the result follows. \square

We finish our discussion of F -positivity by addressing two interesting issues.

Remark 5.8. Schur-positive functions are F -positive by (5.8), but the converse is not true. For example,

$$F_{31} + F_{13} + F_{211} + F_{112} = s_{31} + s_{211} - s_{22}.$$

Therefore, Theorem 5.7 is seemingly stronger than Theorem 5.1. However, we chose to prove Theorem 5.1 separately for two reasons. The first is that our main subject is cylindric skew Schur functions and Schur-positivity. The second reason is that we have been unable to find a symmetric function of the form $K_{P,O}(x)$ that is F -positive but not Schur-positive. No such examples exist for $|P| \leq 7$. Determining whether or not an example exists might be an interesting problem. More generally, we can ask what quasisymmetric functions can be expressed as $K_{P,O}(x)$, or even just as $K_{P,\omega}(x)$. Restricting to symmetric functions, we can also ask how to easily tell when a positive linear combination of Schur functions is equal to a skew Schur function.

Remark 5.9. One might wonder if Theorem 5.7 can be extended to functions that aren't symmetric. Specifically, one might ask if the following statement is true:

Let (P, O) be an oriented poset. Then $K_{P,O}(x)$ is F -positive if and only if (P, O) is a labelled poset.

This statement is false, as shown by the example (P, O) in Figure 12. It has a cycle, but $K_{P,O}(x) = F_{131} + F_{113} + F_{221} + F_{212} + 2F_{122}$.

This further suggests that, among oriented posets, cylindric skew shapes are noteworthy.

Let C be a cylindric skew shape that is not isomorphic to a skew shape. We know from Theorem 4.2 that s_C in k variables is Schur-positive. On the other hand, by Theorem 5.1, s_C in an infinite number of variables is not Schur-positive.

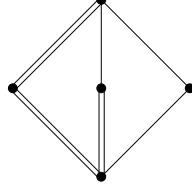

FIGURE 12. An oriented poset (P, O) that is not a labelled poset, but has $K_{P,O}(x)$ F -positive

We conclude this section with a discussion of the minimum number of variables in which s_C fails to be Schur-positive.

As before, let R denote the cylindric ribbon with n elements that runs all the way along the top of C and let $C[-1]$ denote the cylindric skew shape that remains after we remove R from C .

If C is a cylindric ribbon, we deduce from Proposition 5.5 and Lemma 5.3 that s_C remains Schur-positive in $k+1$ variables but always fails to be Schur-positive in $k+2$ variables. By looking at coproducts, we can use this fact to say something about general cylindric skew shapes.

Proposition 5.10. *Let C be a cylindric skew shape that is not isomorphic to a skew shape and that is a subposet of $\mathfrak{C}_{k,n-k}$. If m denotes the maximum number of elements in a column of $C[-1]$, then s_C is not Schur-positive in $m+k+2$ variables.*

Proof. We begin by finding a partition τ such that $s_\tau(x)$ appears with positive coefficient in the Schur expansion of $s_{C[-1]}(x)$. We can form a semistandard cylindric tableau T of shape $C[-1]$ by mapping the i th lowest element of each column to i , for all i . Set τ to be the *content* of T , i.e., $\tau = (\#T^{-1}(1), \#T^{-1}(2), \dots)$. Notice that T is the only semistandard cylindric tableau of shape $C[-1]$ and content τ . Therefore, when we expand $s_{C[-1]}$ in terms of the monomial symmetric functions, m_τ appears with coefficient $+1$. Furthermore, we see that τ is a maximal possible content of a semistandard cylindric tableau of shape $C[-1]$ in *dominance order*. (This means that if σ is some other possible content, then $\sum_{j=1}^i \sigma_j \leq \sum_{j=1}^i \tau_j$ for all $i \geq 1$.) It follows that $s_\tau(x)$ appears with coefficient $+1$ in the Schur expansion of $s_{C[-1]}(x)$. (If this is not clear, see [19, Proposition 7.10.5].)

We know that $s_{(n-k-1, 1^{k+1})}(x)$ appears with coefficient -1 in $s_R(x)$. Looking at $\gamma(s_C)$, we now see that $s_\tau \otimes s_{(n-k-1, 1^{k+1})}$ appears with coefficient -1 . Comparing this with (5.6), we see there exists a partition λ such that:

- (i) $\tau \subseteq \lambda$, and
- (ii) $s_{(n-k-1, 1^{k+1})}$ appears with positive coefficient in the Schur expansion of $s_{\lambda/\tau}$, and
- (iii) $s_\lambda(x)$ appears with coefficient -1 in the Schur expansion of $s_C(x)$.

In particular, we know that $l(\lambda) \leq l(\tau) + l((n-k-1, 1^{k+1})) = m+k+2$. Therefore, $s_\lambda(x_1, \dots, x_{m+k+2}) \neq 0$, and so $s_\lambda(x_1, \dots, x_{m+k+2})$ appears with coefficient -1 in the Schur expansion of $s_C(x_1, \dots, x_{m+k+2})$. \square

We do not claim, and it is not true, that $m+k+2$ is the best possible value. In other words, it can be the case that s_C is not Schur-positive in some number of

variables that is less than $m + k + 2$. For toric shapes, it is clear that $m \leq k - 1$, and so we get the following result.

Corollary 5.11. *Let C be a toric shape that is not isomorphic to a skew shape and that is a subposet of $\mathfrak{C}_{k,n-k}$. Then s_C is not Schur-positive in $2k + 1$ variables.*

6. FROM CYLINDRIC SKEW SHAPES TO SKEW SHAPES

So far, essentially the only tool we have for working with cylindric skew Schur functions is the deletion-minus-reversal rule of (5.2). The subject of this section is a rule for expressing any cylindric skew Schur function as a signed sum of skew Schur functions. Our rule is based on a result of Gessel and Krattenthaler from [7], with our reformulation modelled on a result from [2]. We begin with an exposition of these two results, starting with the latter.

By saying that a partition τ is obtained from λ by adding d n -ribbons, or that λ is obtained from τ by removing d n -ribbons, we mean that there is a sequence of partitions

$$\lambda = \nu_0 \subseteq \nu_1 \subseteq \cdots \subseteq \nu_d = \tau \quad (6.1)$$

such that ν_i/ν_{i-1} is an n -ribbon for $i = 1, \dots, d$. We say that the *width* of a ribbon is its number of non-empty columns. If $\tau_1 \leq n - k$, then we define

$$\varepsilon(\tau/\lambda) = (-1)^{\sum_{i=1}^d (n-k-\text{width}(\nu_i/\nu_{i-1}))}.$$

It can be shown that $\varepsilon(\tau/\lambda)$ is independent of the choice of the sequence in (6.1).

The result of interest from [2] is the following:

Theorem 6.1. *Suppose we have $\lambda, \mu, \nu \subseteq k \times (n - k)$ with $|\mu| + |\nu| = |\lambda| + dn$ for some $d \geq 0$. Then the Gromov-Witten invariant $C_{\mu\nu}^{\lambda,d}$ can be expressed in terms of Littlewood-Richardson coefficients as*

$$C_{\mu\nu}^{\lambda,d} = \sum_{\tau} \varepsilon(\tau/\lambda) c_{\mu\nu}^{\tau}, \quad (6.2)$$

where the sum is over all τ with $\tau_1 \leq n - k$ that can be obtained from λ by adding d n -ribbons.

Formulas for $C_{\mu\nu}^{\lambda,d}$ similar to (6.2) have appeared in different contexts in [4, 8, 9, 23]. Combining Theorems 4.2 and 6.1, we get:

Corollary 6.2. *For any cylindric skew shape $\lambda/d/\mu$ with $\lambda, \mu \subseteq k \times (n - k)$, we have*

$$s_{\lambda/d/\mu}(x_1, \dots, x_k) = \sum_{\tau} \varepsilon(\tau/\lambda) s_{\tau/\mu}(x_1, \dots, x_k), \quad (6.3)$$

where the sum is over all τ with $\tau_1 \leq n - k$ that can be obtained from λ by adding d n -ribbons.

Proof. Multiply both sides of (6.2) by $s_{\nu}(x_1, \dots, x_k)$, sum over all $\nu \subseteq k \times (n - k)$, and apply Theorem 4.2. \square

From our point of view, the obvious disadvantage of Corollary 6.2 is that it only gives certain terms in the expansion of $s_{\lambda/d/\mu}(x)$. For example, for cylindric shapes that are not toric, both sides of (6.3) will be zero. Gessel and Krattenthaler's setting does not have this limitation. To apply their result to get an expression for $s_{\lambda/d/\mu}(x)$, we first have some work to do. Their basic result [7, Proposition 1] is stated in terms of lattice paths. In [7, §9], they show how to apply Proposition

1 to obtain expressions for Schur functions. Mimicking their approach, we first obtain an expression for $s_{\lambda/d/\mu}$ in terms of the elementary symmetric functions. Recall from our construction preceding Remark 4.1 that, for a given $\lambda/d/\mu$, Λ is the unique partition satisfying $\Lambda[-d] = \lambda$. In this case, we also write $\lambda[d] = \Lambda$ and we see that Λ is obtained from λ by adding d n -ribbons, each starting in λ 's rightmost column (column $n - k$) and ending in column 1. We get that ²

$$s_{\lambda/d/\mu}(x) = \sum_{\substack{r_1 + \dots + r_{n-k} = 0 \\ r_i \in \mathbb{Z}}} \det \left(e_{r_s n + \Lambda'_s - \mu'_t - s + t}(x) \right)_{s,t=1}^{n-k}. \quad (6.4)$$

As usual, we set $e_0 = 1$ and $e_i = 0$ for $i < 0$. The alert reader may notice the possibility of greatly simplifying (6.4) using the dual Jacobi-Trudi identity (see [10, I, (5.5)] or [19, Corollary 7.16.2]):

$$s_{\tau'/\mu}(x) = \det \left(e_{\tau_s - \mu'_t - s + t}(x) \right)_{s,t=1}^{n-k},$$

where $\mu \subseteq \tau'$ and $\tau_1 \leq n - k$. Indeed, given $r = (r_1, \dots, r_{n-k})$, let $\Lambda' + rn$ denote the integer sequence $(\Lambda'_1 + r_1 n, \dots, \Lambda'_{n-k} + r_{n-k} n)$. Now $\Lambda' + rn$ may not be a partition. However, we can still define the Schur function $s_{\alpha'/\mu}$ for any sequence $\alpha = (\alpha_1, \dots, \alpha_{n-k})$ using a dual Jacobi-Trudi determinant:

$$s_{\alpha'/\mu} = \det \left(e_{\alpha_s - \mu'_t - s + t} \right)_{s,t=1}^{n-k}. \quad (6.5)$$

By repeatedly transposing adjacent rows, it may be possible to make the matrix on the right-hand side of (6.5) into the dual Jacobi-Trudi matrix of a skew shape τ'/μ , multiplied by a sign term $(-1)^{\delta(\alpha)}$. For example,

$$\begin{aligned} s_{(7,-2,4,11)'/(2,1,0,0)} &= \begin{vmatrix} e_5 & e_7 & e_9 & e_{10} \\ e_{-5} & e_{-3} & e_{-1} & e_0 \\ e_0 & e_2 & e_4 & e_5 \\ e_6 & e_8 & e_{10} & e_{11} \end{vmatrix} = + \begin{vmatrix} e_6 & e_8 & e_{10} & e_{11} \\ e_5 & e_7 & e_9 & e_{10} \\ e_0 & e_2 & e_4 & e_5 \\ e_{-5} & e_{-3} & e_{-1} & e_0 \end{vmatrix} \\ &= s_{(8,8,4,0)'/(2,1,0,0)}. \end{aligned}$$

To save us having to always think in terms of determinants, we can view this process another way. Effectively what we are doing is defining an equivalence relation \sim on integer sequences by saying that

$$(\alpha_1, \alpha_2, \dots, \alpha_{n-k}) \sim (\alpha_1, \dots, \alpha_{i-1}, \alpha_{i+1} - 1, \alpha_i + 1, \alpha_{i+2}, \dots, \alpha_{n-k}) :$$

we transpose two adjacent elements of the sequence, increasing the element moving right by 1 and decreasing the element moving left by 1. We see that every equivalence class of a sequence α contains at most one partition τ . If τ' contains μ then we say that $s_{\alpha'/\mu} = (-1)^{\delta(\alpha)} s_{\tau'/\mu}$ whenever $\alpha \sim \tau$, where $\delta(\alpha)$ is the number of adjacent transpositions necessary to make α into a partition. If τ' does not contain μ or if α does not have a partition in its equivalence class, then we set $s_{\alpha'/\mu} = 0$. One can check that this is consistent with the definition (6.5) of $s_{\alpha'/\mu}$ as a determinant. In our example above, we would have had

$$\alpha = (7, -2, 4, 11) \sim (7, 3, -1, 11) \sim (7, 3, 10, 0) \sim (7, 9, 4, 0) \sim (8, 8, 4, 0) = \tau$$

and $\delta(\alpha) = 4$.

Putting this all together, (6.4) becomes:

² For the benefit of the reader wishing to derive (6.4) from [7], we note that we took $z = 1$, $\mathbf{S} = (-n, n)$, $w(e) = x_{i+j}$, $n = m$, $u_i = -(\Lambda'_i + n - k - i), \Lambda'_i + n - k - i$, $v_i = -(\mu'_i + n - k - i), \mu'_i + n - k - i + m$, $r_i = -k_i$, and we let m tend to infinity.

r	$\Lambda' + rn$	τ	$\delta(\Lambda' + rn)$
(0, 0, 0, 0)	(7, 5, 4, 4)	(7, 5, 4, 4)	0
(-1, 0, 0, 1)	(0, 5, 4, 11)	(8, 5, 4, 3)	5
(-1, 0, 1, 0)	(0, 5, 11, 4)	(9, 5, 3, 3)	4
(-1, 1, 0, 0)	(0, 12, 4, 4)	(11, 3, 3, 3)	3
(0, -1, 0, 1)	(7, -2, 4, 11)	(8, 8, 4, 0)	4
(0, -1, 1, 0)	(7, -2, 11, 4)	(9, 8, 3, 0)	3
(1, -1, 0, 0)	(14, -2, 4, 4)	(14, 3, 3, 0)	2
(-1, -1, 1, 1)	(0, -2, 11, 11)	(9, 9, 2, 0)	4
(-1, -1, 0, 2)	(0, -2, 4, 18)	(15, 3, 2, 0)	5
(-1, -1, 2, 0)	(0, -2, 18, 4)	(16, 2, 2, 0)	4

TABLE 2. Applying Theorem 6.3 to $\lambda/d/\mu = (3, 3)/2/(2, 1)$

Theorem 6.3. [7] *For any cylindric shape $\lambda/d/\mu$ that is a subposet of $\mathfrak{C}_{k, n-k}$, we have*

$$s_{\lambda/d/\mu}(x) = \sum_{\substack{r_1 + \dots + r_{n-k} = 0 \\ r_i \in \mathbb{Z}}} s_{(\Lambda' + rn)'/\mu}(x)$$

where $\Lambda = \lambda[d]$.

Example 6.4. Consider $\lambda/d/\mu = (3, 3)/2/(2, 1)$ as depicted in Figure 9. We see that $n = 7$, $n - k = 4$, $\Lambda' = (7, 5, 4, 4)$ and $\mu = (2, 1, 0, 0)$. The values of $r = (r_1, \dots, r_{n-k})$ that make $s_{(\Lambda' + rn)'/\mu} \neq 0$ are listed in the first column of Table 2. We conclude that

$$\begin{aligned} s_{(3,3)/2/(2,1)}(x) &= s_{(7,5,4,4)'/2,(1)}(x) - s_{(8,5,4,3)'/2,(1)}(x) + s_{(9,5,3,3)'/2,(1)}(x) \\ &\quad - s_{(11,3,3,3)'/2,(1)}(x) + s_{(8,8,4,0)'/2,(1)}(x) - s_{(9,8,3,0)'/2,(1)}(x) \\ &\quad + s_{(14,3,3,0)'/2,(1)}(x) + s_{(9,9,2,0)'/2,(1)}(x) - s_{(15,3,2,0)'/2,(1)}(x) \\ &\quad + s_{(16,2,2,0)'/2,(1)}(x). \end{aligned}$$

Using Theorem 6.3, we can actually show that Corollary 6.2 extends to the case of infinitely many variables. This is the main result of this section.

Theorem 6.5. *For any cylindric skew shape $\lambda/d/\mu$ that is a subposet of $\mathfrak{C}_{k, n-k}$, we have*

$$s_{\lambda/d/\mu}(x) = \sum_{\tau} \varepsilon(\tau/\lambda) s_{\tau/\mu}(x), \quad (6.6)$$

where the sum is over all τ with $\tau_1 \leq n - k$ that can be obtained from λ by adding d n -ribbons.

Note 6.6. While $\lambda \subseteq k \times (n - k)$ by definition, we do not require that $l(\mu) \leq k$, unlike in Theorem 6.1 and Corollary 6.2.

Example 6.7. Again, consider $\lambda/d/\mu = (3, 3)/2/(2, 1)$ as depicted in Figure 9. Figure 13 shows the set of all possible $\varepsilon(\tau/\lambda)\tau/\mu$ with $\tau_1 \leq n - k$ such that τ can be obtained from $(3, 3)$ by adding two 7-ribbons. The positioning of the partitions in the figure is supposed to be helpful, as it is determined by the rightmost column of the added ribbons. There can be more than one way to add ribbons to λ and get a particular τ , but this does not affect our expression for $s_{\lambda/d/\mu}$.

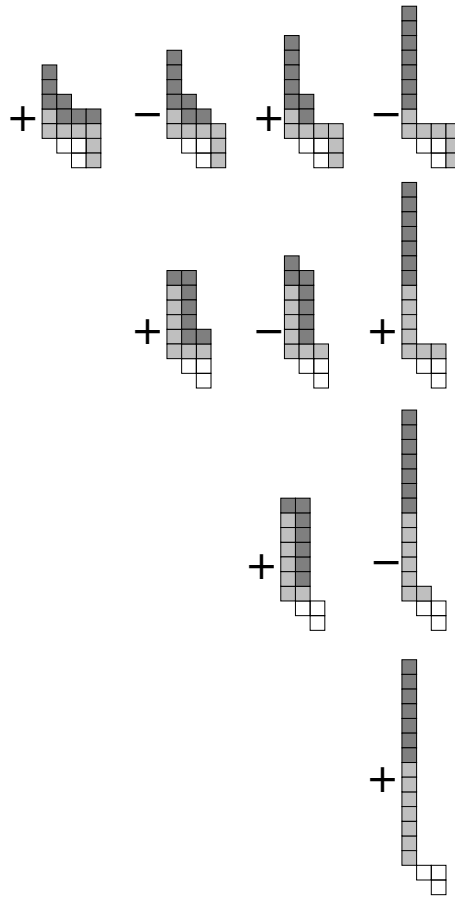

FIGURE 13. All possible $\varepsilon(\tau/\lambda)\tau/\mu$ in Theorem 6.5 when $\lambda/d/\mu = (3, 3)/2/(2, 1)$

We see that we get the same result as in Example 6.4. While the result obtained from Theorem 6.3 is more compact to write, we find the graphical description of $s_{\lambda/d/\mu}$ in Theorem 6.5 preferable, especially from the point of view of intuition. We will make much use of Theorem 6.5 in the next section.

Remark 6.8. Because the expression of a cylindric skew shape C in the form $\lambda/d/\mu$ is not unique, Theorem 6.5 can be used to give a host of identities among skew Schur functions. For example, consider the cylindric skew shape C shown in Figure 14 with $k = n - k = 3$. By choosing the origins labelled 1, 2 and 3 respectively, we see that C can be written as $(3, 3, 1)/1/(2, 1)$, $(3, 2, 2)/1/(2, 1)$ or $(1)/2/(2, 1)$. It follows that

$$\begin{aligned}
 s_C(x) &= s_{333211/21} - s_{3322111/21} + s_{331111111/21} \\
 &= s_{33331/21} - s_{32221111/21} + s_{322111111/21} \\
 &= s_{33322/21} - s_{3222211/21} + s_{321111111/21} + s_{2222221/21} - s_{221111111/21}.
 \end{aligned}$$

The remainder of this section, which is somewhat technical, is devoted to working towards and proving Theorem 6.5. It does not seem that the proof of Theorem 6.1

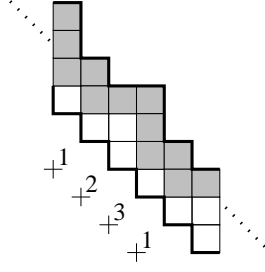
FIGURE 14. $(3, 3, 1)/1/(2, 1) = (3, 2, 2)/1/(2, 1) = (1)/2/(2, 1)$

from [2] can be easily modified to work in this more general setting. Instead, our approach will show that the statements of Theorems 6.3 and 6.5 are equivalent, thereby implying Theorem 6.5.

We begin with some preliminary results about the \sim equivalence relation. Rather than working with integer sequences, it will be more convenient to work now with *signed* integer sequences. A signed integer sequence is simply an integer sequence with a purely symbolic sign in front. By this, we mean that $-(\alpha_1, \dots, \alpha_{n-k})$ is certainly not the same thing as $(-\alpha_1, \dots, -\alpha_{n-k})$. However, we will say that $-(-(\alpha_1, \dots, \alpha_{n-k})) = (\alpha_1, \dots, \alpha_{n-k})$. We extend \sim to the class of signed integer sequences by saying that

$$(\alpha_1, \alpha_2, \dots, \alpha_{n-k}) \sim -(\alpha_1, \dots, \alpha_{i-1}, \alpha_{i+1} - 1, \alpha_i + 1, \alpha_{i+2}, \dots, \alpha_{n-k}),$$

i.e., the sign changes when we do an adjacent transposition. Signed partitions are then defined in the obvious way, and we denote the set of signed partitions by $SPar$. We identify the partition λ with the signed partition $+\lambda$.

We remark that a signed integer sequence $\pm(\alpha_1, \dots, \alpha_{n-k})$ may not always have a signed partition in its equivalence class. For example, any signed sequence equivalent to $-(7, 4, 0, -2)$ will always have a negative entry in its sequence. More interestingly, there is no signed sequence in the equivalence class of $(7, 4, 5, 0)$ whose sequence is weakly decreasing. However, we see that any integer sequence $\alpha = (-1)^k(\alpha_1, \dots, \alpha_{n-k})$ is equivalent to a unique signed integer sequence $\beta = (-1)^{k+\delta(\alpha)}(\beta_1, \beta_2, \dots, \beta_{n-k})$ with

$$\beta_1 - 1 \geq \beta_2 - 2 \geq \dots \geq \beta_{n-k} - (n - k).$$

Here $\delta(\alpha)$ is the number of adjacent transpositions necessary to convert α to β . We then denote this signed sequence β by $\langle\langle \alpha_1, \dots, \alpha_{n-k} \rangle\rangle$ or just $\langle \alpha_1, \dots, \alpha_{n-k} \rangle$. Finally, if α is a signed integer sequence, we let $\alpha \uparrow_i m$ denote the signed integer sequence that results when we increase the i th element of α by m , but leave the sign of α unchanged. Using a similar principle, $\alpha + (r_1, \dots, r_{n-k})n$ denotes the signed integer sequence that results when we increase the i th element of α by $r_i n$ for $i = 1, \dots, n - k$, but leave the sign of α unchanged.

Our first lemma, while only a small portion of the work to come, highlights the basic connection between ribbons and the \sim equivalence relation.

Lemma 6.9. (a) *For a partition τ with $\tau_1 \leq n - k$, suppose we can add an n -ribbon to τ whose rightmost column is column i to get a new partition σ . Then σ exists if and only if $\langle \tau' \uparrow_i n \rangle$ is a signed partition, in which case $\varepsilon(\sigma/\tau)\sigma' = (-1)^{n-k-1}\langle \tau' \uparrow_i n \rangle$.*

- (b) For a partition τ with $\tau_1 \leq n - k$, suppose we can remove an n -ribbon from τ whose leftmost column is column i to get a new partition σ . Then σ exists if and only if $\langle \tau' \uparrow_i - n \rangle$ is a signed partition, in which case $\varepsilon(\sigma/\tau)\sigma' = (-1)^{n-k-1} \langle \tau' \uparrow_i - n \rangle$.

Proof. We prove (a), with (b) being similar. We have that

$$\begin{aligned}
& (-1)^{n-k-1} \langle \tau' \uparrow_i n \rangle \\
&= (-1)^{n-k-1} \langle \tau'_1, \dots, \tau'_{i-1}, \tau'_i + n, \tau'_{i+1}, \dots, \tau'_{n-k} \rangle \\
&= (-1)^{n-k-1+i-j} \langle \tau'_1, \dots, \tau'_{j-1}, \tau'_i + n - (i-j), \tau'_j + 1, \dots, \tau'_{i-1} + 1, \\
&\quad \tau'_{i+1}, \dots, \tau'_{n-k} \rangle, \tag{6.7}
\end{aligned}$$

where we take j to be as small as possible subject to the condition that $\tau'_i + n - (i-j) \geq \tau'_j + 1$. We observe that (6.7) gives exactly the column heights of the result σ of adding an n -ribbon to τ whose rightmost column is i and whose leftmost column is as far left as possible. Obviously, σ is a partition if and only if (6.7) is a signed partition. (This is the case if and only if $\tau'_{j-1} \geq \tau'_i + n - (i-j)$.) Finally, $\varepsilon(\sigma/\tau) = (-1)^{n-k-(i-j+1)}$, as required. \square

The next lemma encompasses the remaining preliminaries necessary for proving Theorem 6.5.

Lemma 6.10. *Suppose $\lambda/d/\mu$ with $d \geq 1$ is a cylindric skew shape. Let $r = (r_1, \dots, r_{n-k})$ be an integer sequence, and let $\Lambda = \lambda[d]$.*

- (a) *If $\langle \Lambda' + rn \rangle = \langle \Lambda' + tn \rangle$ for some integer sequence $t = (t_1, \dots, t_{n-k})$, then $r = t$.*
(b) *$\langle \Lambda' + rn \rangle$ is a weakly decreasing sequence.*
(c) *If $r_1 + \dots + r_{n-k} = 0$, then $\langle \Lambda' + rn \rangle_1 \geq k + 1$.*
(d) *If $r_1 + \dots + r_{n-k} = 0$ and $\langle \Lambda' + rn \rangle$ is a signed partition, then the signed sequence $\langle \langle \Lambda' + rn \rangle \uparrow_1 - n \rangle$ is a signed partition.*

Proof. (a) Suppose that $\langle \Lambda' + rn \rangle = \pm(\tau_1, \dots, \tau_{n-k})$. Then for some set $\{i_1, \dots, i_{n-k}\} = \{1, \dots, n-k\}$ we have the following congruences modulo n :

$$\begin{aligned}
\tau_1 &\equiv \Lambda'_{i_1} + (1 - i_1) \\
\tau_2 &\equiv \Lambda'_{i_2} + (2 - i_2) \\
&\vdots \\
\tau_{n-k} &\equiv \Lambda'_{i_{n-k}} + (n - k - i_{n-k}).
\end{aligned}$$

Now $\Lambda'_i - i \neq \Lambda'_j - j$ for $i \neq j$. Furthermore, for all s and t , $|i_s - i_t| \leq n - k - 1$, while $|\Lambda'_s - \Lambda'_t| \leq k$ by Remark 4.1(iv). Combining these observations, we see that, for $i \neq j$, we have $\Lambda'_i - i \not\equiv \Lambda'_j - j \pmod{n}$. Therefore, the value of $\tau_j - j$ determines $\Lambda'_{i_j} - i_j$, and hence determines i_j for all j . Therefore, τ determines r , implying the result.

(b) If $\langle \Lambda' + rn \rangle$ is not a decreasing sequence, then $\tau_j + 1 = \tau_{j+1}$ for some j . The congruences above therefore imply that

$$\Lambda'_{i_j} + (j - i_j) + 1 \equiv \Lambda'_{i_{j+1}} + (j + 1 - i_{j+1}) \pmod{n}.$$

which we saw was impossible for $i_j \neq i_{j+1}$.

(c) Suppose $r_1 \geq 0$. Then $\langle \Lambda' + rn \rangle_1 \geq \Lambda'_1 + r_1 n \geq \Lambda'_1 > k$, since $d \geq 1$. Now suppose $r_1 < 0$. Therefore, $r_i > 0$ for some $2 \leq i \leq n - k$. We have

$$\langle \Lambda' + rn \rangle_1 \geq \Lambda'_i + r_i n - (i - 1) \geq 0 + n - (n - k - 1) = k + 1.$$

(d) Observe that there exists an integer sequence $\bar{r} = (\bar{r}_1, \dots, \bar{r}_{n-k})$ such that $\langle \langle \Lambda' + rn \rangle \uparrow_1 - n \rangle = \langle \Lambda' + \bar{r}n \rangle$. Thus, (b) implies that $\langle \langle \Lambda' + rn \rangle \uparrow_1 - n \rangle$ is a weakly decreasing sequence. It remains to show that $\langle \langle \Lambda' + rn \rangle \uparrow_1 - n \rangle_{n-k} \geq 0$. Now $\langle \langle \Lambda' + rn \rangle \uparrow_1 - n \rangle$ is obtained from $\langle \Lambda' + rn \rangle \uparrow_1 - n$ by applying adjacent transpositions to move the first entry $\langle \Lambda' + rn \rangle_1 - n$ to the right until it has no more larger entries to its right. There are two possibilities. Either it gets moved all the way to the $(n - k)$ th position, in which case

$$\langle \langle \Lambda' + rn \rangle \uparrow_1 - n \rangle_{n-k} = \langle \Lambda' + rn \rangle_1 - n + (n - k - 1) \geq 0$$

by (c). Alternatively, it has no larger entries to its right before it reaches the $(n - k)$ th position, in which case

$$\langle \langle \Lambda' + rn \rangle \uparrow_1 - n \rangle_{n-k} = \langle \langle \Lambda' + rn \rangle \uparrow_1 - n \rangle_{n-k} = \langle \Lambda' + rn \rangle_{n-k} \geq 0$$

since $\langle \Lambda' + rn \rangle$ is a partition. □

Proof of Theorem 6.5. We use Theorem 6.3 as our starting point. We must show that for any $\lambda/d/\mu$ that is a subset of $\mathfrak{C}_{k,n-k}$,

$$\sum_{\substack{r_1 + \dots + r_{n-k} = 0 \\ r_i \in \mathbb{Z}}} s_{(\Lambda' + rn)'/\mu}(x) = \sum_{\tau} \varepsilon(\tau/\lambda) s_{\tau/\mu}(x), \quad (6.8)$$

where $\Lambda = \lambda[d]$ and where the sum on the right-hand side is over all τ with $\tau_1 \leq n - k$ that can be obtained from λ by adding d n -ribbons. First, notice that μ plays a very straightforward role. In particular, if (6.8) holds for $\lambda/d/\emptyset$, then it holds for $\lambda/d/\mu$. Therefore, we will assume that $\mu = \emptyset$. Define two multisets L_d and R_d of signed integer sequences as follows:

$$\begin{aligned} L_d &= \{ \langle \lambda[d]' + rn \rangle \in SPar \mid r_i \in \mathbb{Z}, r_1 + \dots + r_{n-k} = 0 \}, \\ R_d &= \{ \varepsilon(\tau/\lambda)\tau' \in SPar \mid \tau_1 \leq n - k, \tau \text{ can be obtained} \\ &\quad \text{from } \lambda \text{ by adding } d \text{ } n\text{-ribbons} \}. \end{aligned}$$

We see that showing (6.8) amounts to showing that $L_d = R_d$. Every element of R_d occurs with multiplicity 1 by definition, and every element of L_d occurs with multiplicity 1 by Lemma 6.10(a). So L_d and R_d are, in fact, just sets.

Suppose first that $d = 0$, in which case $R_d = \{\lambda'\}$. Because $\Lambda' = \lambda'$ and $\lambda'_i \leq k$ for all i , we see that the signed sequence $\langle \Lambda' + rn \rangle$ will have a negative entry unless $r_i = 0$ for all i . Therefore, $L_0 = \{\lambda'\}$ also.

Now suppose that $d > 0$, and assume by induction that $L_{d-1} = R_{d-1}$. Define IL_d to be the set of signed partitions given by

$$IL_d = \{ (-1)^{n-k-1} \langle \alpha \uparrow_i n \rangle \in SPar \mid \alpha \in L_{d-1}, 1 \leq i \leq n - k \}.$$

IL_d can be thought of as an inductive version of L_d . That $IL_d = R_d$ is exactly the content of Lemma 6.9(a), combined with the induction hypothesis. It remains to show that $IL_d = L_d$.

We know that $\Lambda[-1] = \lambda[d - 1]$ is obtained from $\Lambda = \lambda[d]$ by removing an n -ribbon whose leftmost column is column 1 and whose rightmost column is column

$n - k$. Lemma 6.9(b) then implies that $\Lambda[-1]' = (-1)^{n-k-1} \langle \Lambda' \uparrow_1 - n \rangle$ as signed partitions. Also, Lemma 6.9(a) implies that $\Lambda' = (-1)^{n-k-1} \langle \Lambda[-1]' \uparrow_{n-k} n \rangle$.

Towards showing that $IL_d \subseteq L_d$, we next consider $\alpha = \langle \Lambda[-1]' + \bar{r}n \rangle \in L_{d-1}$ with $\bar{r}_1 + \cdots + \bar{r}_{n-k} = 0$. Since $\Lambda'_1 \geq \Lambda'_2 \geq \cdots \geq \Lambda'_{n-k} \geq \Lambda'_1 - k$, we get

$$\begin{aligned} & \langle \Lambda[-1]' + \bar{r}n \rangle \\ &= (-1)^{n-k-1} \langle \langle \Lambda' \uparrow_1 - n \rangle + \bar{r}n \rangle \\ &= (-1)^{n-k-1} \langle (\Lambda'_2 - 1, \Lambda'_3 - 1, \dots, \Lambda'_{n-k} - 1, \Lambda'_1 - n + (n - k - 1)) + \bar{r}n \rangle \\ &= (-1)^{n-k-1} \langle (\Lambda'_2 - 1 + \bar{r}_1 n, \dots, \Lambda'_{n-k} - 1 + \bar{r}_{n-k-1} n, \Lambda'_1 - k - 1 + \bar{r}_{n-k} n) \rangle \\ &= (-1)^{n-k-1} \langle \Lambda' + (\bar{r}_{n-k} - 1, \bar{r}_1, \bar{r}_2, \dots, \bar{r}_{n-k-1})n \rangle. \end{aligned}$$

Now suppose we take $\beta = (-1)^{n-k-1} \langle \alpha \uparrow_i n \rangle \in IL_d$. We have

$$\begin{aligned} \beta &= (-1)^{n-k-1} \langle (-1)^{n-k-1} \langle \Lambda' + (\bar{r}_{n-k} - 1, \bar{r}_1, \bar{r}_2, \dots, \bar{r}_{n-k-1})n \rangle \uparrow_i n \rangle \\ &= (-1)^{n-k-1} (-1)^{n-k-1} \langle \Lambda' + rn \rangle. \end{aligned}$$

for suitable choice of $r = (r_1, \dots, r_{n-k})$ with $r_1 + \cdots + r_{n-k} = 0$. Therefore, $\beta \in L_d$ and so $IL_d \subseteq L_d$.

Now suppose we take any $\beta = \langle \Lambda' + rn \rangle \in L_d$. By Lemma 6.10(d), $\langle \beta \uparrow_1 - n \rangle = \langle \langle \Lambda' + rn \rangle \uparrow_1 - n \rangle$ is a signed partition, which we choose to denote by $(-1)^{n-k-1} \alpha$. It follows that $\beta = \langle (-1)^{n-k-1} \alpha \uparrow_i n \rangle = (-1)^{n-k-1} \langle \alpha \uparrow_i n \rangle$ for some i . Now

$$\begin{aligned} \alpha &= (-1)^{n-k-1} \langle \langle \Lambda' + rn \rangle \uparrow_1 - n \rangle \\ &= (-1)^{n-k-1} \langle \langle (-1)^{n-k-1} \langle \Lambda[-1]' \uparrow_{n-k} n \rangle + rn \rangle \uparrow_1 - n \rangle \\ &= (-1)^{n-k-1} (-1)^{n-k-1} \langle \Lambda[-1]' + \bar{r}n \rangle \end{aligned}$$

for suitable choice of $\bar{r} = (\bar{r}_1, \dots, \bar{r}_{n-k})$ with $\bar{r}_1 + \cdots + \bar{r}_{n-k} = 0$. We conclude that $\alpha \in L_{d-1}$ and hence $\beta \in IL_d$. Therefore $L_d \subseteq IL_d$ and so $L_d = IL_d$. \square

7. CYLINDRIC SCHUR-POSITIVITY

Before presenting the conjecture which is the main subject of this section, we begin with a relevant application of Theorem 6.5.

In the same way that Schur functions are those skew Schur functions $s_{\lambda/\mu}(x)$ with $\mu = \emptyset$, we will say that *cylindric Schur functions* are those cylindric skew Schur functions $s_{\lambda/d/\mu}(x)$ with $\mu = \emptyset$. While the Schur functions are known to be a basis for the symmetric functions, we have the following result for the cylindric Schur functions.

Proposition 7.1. *For a given $k, n - k$, the cylindric Schur functions of the form $s_{\lambda/d/\emptyset}(x)$, with $\lambda/d/\emptyset$ a subposet of $\mathfrak{C}_{k, n-k}$, are linearly independent.*

Proof. Consider the expansion (6.6) of a cylindric skew Schur function $s_{\lambda/d/\mu}(x)$ in terms of skew Schur functions. When $\mu = \emptyset$, this expansion is in terms of Schur functions. Furthermore, a Schur function s_ν can only appear in the Schur expansion of $s_{\lambda/d/\emptyset}(x)$ if λ is the n -core of ν . It follows that when we take a linear combination of cylindric Schur functions of the form $s_{\lambda/d/\emptyset}(x)$ having $\lambda/d/\emptyset$ a subposet of $\mathfrak{C}_{k, n-k}$, we don't get any cancellation among the Schur expansions of the cylindric Schur functions. In particular, the cylindric Schur functions are linearly independent. \square

We might next ask if every cylindric skew Schur function $s_{\lambda/d/\mu}(x)$ with $\lambda/d/\mu$ a subsubset of $\mathfrak{C}_{k,n-k}$ can be expressed as a linear combination of cylindric Schur functions of the form $s_{\nu/e/\emptyset}(x)$, where each $\nu/e/\emptyset$ is also a subsubset of $\mathfrak{C}_{k,n-k}$. As we shall see, an affirmative answer to this question would also imply Conjecture 7.3 below.

Definition 7.2. Suppose $\lambda/d/\mu$ is a cylindric skew shape that is a subsubset of $\mathfrak{C}_{k,n-k}$. We say that $s_{\lambda/d/\mu}(x)$ in the variables $x = (x_1, x_2, \dots)$ is *cylindric Schur-positive* if it can be expressed as a linear combination of cylindric Schur functions $s_{\nu/e/\emptyset}(x)$ with positive coefficients, where each such $\nu/e/\emptyset$ is also a subsubset of $\mathfrak{C}_{k,n-k}$.

As an analogue of the fact that every skew Schur function is Schur-positive, we propose the following conjecture.

Conjecture 7.3. *Every cylindric skew Schur function is cylindric Schur-positive.*

As we noted in Remark 5.6, this conjecture is true for cylindric ribbons. The rest of this section will be devoted to other evidence in favour of the conjecture.

It follows from (4.2) that we can split $s_{\lambda/d/\mu}(x)$ into two sums as follows:

$$s_{\lambda/d/\mu}(x) = \sum_{\nu \subseteq k \times (n-k)} a_{\nu} s_{\nu}(x) + \sum_{\substack{\nu: \nu_1 \leq n-k \\ l(\nu) > k}} b_{\nu} s_{\nu}(x). \quad (7.1)$$

When $\nu \subseteq k \times (n-k)$, we know that $s_{\nu}(x)$ is a cylindric Schur function. Furthermore, we know from Theorem 4.2 that $a_{\nu} \geq 0$ for all $\nu \subseteq k \times (n-k)$. Therefore, the first sum is cylindric Schur-positive.

Now consider the second sum, which we denote by $B(\lambda/d/\mu, x)$. We know that $s_{\lambda/d/\mu}(x)$ is cylindric Schur-positive when $d = 0$. Therefore, we can assume by induction that $s_{\lambda/(d-1)/\mu}(x)$ is cylindric Schur-positive:

$$s_{\lambda/(d-1)/\mu}(x) = \sum_{\substack{\nu, e \\ \nu \subseteq k \times (n-k)}} c_{\nu, e} s_{\nu/e/\emptyset}(x), \quad (7.2)$$

where $c_{\nu, e} \geq 0$ for all ν, e , and e is a always non-negative integer. (For $c_{\nu, e} \neq 0$, we need that $ne = |\lambda| - |\mu| + n(d-1) - |\nu|$.) We conjecture, in fact, that $B(\lambda/d/\mu, x)$ can be expressed exactly in terms of $s_{\lambda/(d-1)/\mu}(x)$ as:

$$B(\lambda/d/\mu, x) = \sum_{\substack{\nu, e \\ \nu \subseteq k \times (n-k)}} c_{\nu, e} s_{\nu/e+1/\emptyset}(x).$$

Plugging this into (7.1), we get

$$s_{\lambda/d/\mu}(x) = \sum_{\nu \subseteq k \times (n-k)} a_{\nu} s_{\nu}(x) + \sum_{\substack{\nu, e \\ \nu \subseteq k \times (n-k)}} c_{\nu, e} s_{\nu/e+1/\emptyset}(x), \quad (7.3)$$

where $a_{\nu}, c_{\nu, e} \geq 0$ for all ν, e . This expression is a strong refinement of Conjecture 7.3 as it gives much information about the form of the cylindric Schur-positive expansion of $s_{\lambda/d/\mu}(x)$. Using [3, 21] we have verified (7.3) for all $\lambda/d/\mu$ with $k, n-k, d \leq 5$.

One way to show (7.3) would be to show that the coefficient of $s_{\sigma}(x)$ is the same on both sides for all partitions σ with $|\sigma| = |\lambda| + nd - |\mu|$. Since we are only worried about the cylindric Schur-positivity of $B(\lambda/d/\mu, x)$, assume that $\sigma_1 \leq n-k$ but $l(\sigma) > k$. There is a certain important class of such partitions σ for which we can show $s_{\sigma}(x)$ has the same coefficient on both sides of (7.3):

Proposition 7.4. *Suppose we are given a cylindric shape $\lambda/d/\mu$ which is a subposet of $\mathfrak{C}_{k,n-k}$ and, to avoid trivialities, we take $d \geq 1$. Consider a partition σ with $|\sigma| = |\lambda| + nd - |\mu|$, $\sigma_1 \leq n - k$, $l(\sigma) > k$ and the additional condition that*

$$\sigma'_1 \geq \sigma'_2 \geq \cdots \geq \sigma'_{n-k} \geq \sigma'_1 - k. \quad (7.4)$$

Then

$$[s_\sigma(x)]s_{\lambda/d/\mu}(x) = [s_\sigma(x)] \sum_{\substack{\nu, e \\ \nu \subseteq k \times (n-k)}} c_{\nu, e} s_{\nu/e+1/\emptyset}(x),$$

where

$$s_{\lambda/(d-1)/\mu}(x) = \sum_{\substack{\nu, e \\ \nu \subseteq k \times (n-k)}} c_{\nu, e} s_{\nu/e/\emptyset}(x).$$

Proof. The key idea is that since σ satisfies (7.4), $\lambda/d/\sigma$ is a valid cylindric shape. Because of the conditions on σ , we also know that $\sigma[-1]$ is a well-defined partition. Indeed, by (7.4) we know that $\sigma'_{n-k} > 0$ and

$$\sigma[-1]' = (\sigma'_2 - 1, \dots, \sigma'_{n-k} - 1, \sigma'_1 - k - 1).$$

By Theorem 6.5, we have

$$\begin{aligned} [s_\sigma(x)]s_{\lambda/d/\mu}(x) &= [s_\sigma(x)] \sum_{\tau} \varepsilon(\tau/\lambda) s_{\tau/\mu}(x) \\ &= \sum_{\tau} \varepsilon(\tau/\lambda) c_{\mu\sigma}^{\tau} \\ &= [s_{\mu}(x)] \sum_{\tau} \varepsilon(\tau/\lambda) s_{\tau/\sigma}(x) \\ &= [s_{\mu}(x)]s_{\lambda/d/\sigma}(x), \end{aligned}$$

where the sums are over all τ with $\tau_1 \leq n - k$ that can be obtained from λ by adding d n -ribbons, and where $c_{\mu\sigma}^{\tau}$ denotes the Littlewood-Richardson coefficient. By Remark 4.1(ii), $\lambda/d/\sigma$ and $\lambda/(d-1)/\sigma[-1]$ are the same cylindric skew shape. Therefore, now with the sums over all τ with $\tau_1 \leq n - k$ that can be obtained from λ by adding $d-1$ n -ribbons, we have

$$\begin{aligned} [s_\sigma(x)]s_{\lambda/d/\mu}(x) &= [s_{\mu}(x)]s_{\lambda/(d-1)/\sigma[-1]}(x) \\ &= [s_{\mu}(x)] \sum_{\tau} \varepsilon(\tau/\lambda) s_{\tau/\sigma[-1]}(x) \\ &= \sum_{\tau} \varepsilon(\tau/\lambda) c_{\mu\sigma[-1]}^{\tau} \\ &= [s_{\sigma[-1]}(x)]s_{\lambda/(d-1)/\mu}(x) \\ &= [s_{\sigma[-1]}(x)] \sum_{\substack{\nu, e \\ \nu \subseteq k \times (n-k)}} c_{\nu, e} s_{\nu/e/\emptyset}(x). \end{aligned}$$

However, since σ and $\sigma[-1]$ have the same n -core,

$$[s_{\sigma[-1]}(x)] \sum_{\substack{\nu, e \\ \nu \subseteq k \times (n-k)}} c_{\nu, e} s_{\nu/e/\emptyset}(x) = [s_{\sigma}(x)] \sum_{\substack{\nu, e \\ \nu \subseteq k \times (n-k)}} c_{\nu, e} s_{\nu/e+1/\emptyset}(x),$$

as required. \square

As promised, we can now reformulate Conjecture 7.3 into a seemingly easier statement.

Corollary 7.5. *Conjecture 7.3 holds if and only if every cylindric skew Schur function $s_{\lambda/d/\mu}(x)$ with $\lambda/d/\mu$ a subposet of $\mathfrak{C}_{k,n-k}$ can be expressed as a linear combination of cylindric Schur functions $s_{\nu/e/\emptyset}(x)$, where each $\nu/e/\emptyset$ is also a subposet of $\mathfrak{C}_{k,n-k}$.*

In other words, to prove Conjecture 7.3, we don't have to show that the coefficients are positive.

Proof. The “only if” direction is trivial. So suppose $s_{\lambda/d/\mu}(x)$ can be expressed as a linear combination of cylindric Schur functions. Let $s_{\nu/m/\emptyset}(x)$ be a cylindric Schur function that appears with coefficient $a_{\nu,m}$ in this linear combination. We need to show that $a_{\nu,m} \geq 0$. Assume that $|\lambda| + dn - |\mu| = |\nu| + mn$, since otherwise $a_{\nu,m} = 0$. We proceed by induction on d , with the case $d = 0$ being trivial.

If $m = 0$, we know by (7.1) that $a_{\nu,m} \geq 0$. Therefore, assume that $m \geq 1$. Consider $\sigma = \nu[m]$. Using the fact that $\nu \subseteq k \times (n - k)$, we can check that σ satisfies

$$\sigma'_1 \geq \sigma'_2 \geq \cdots \geq \sigma'_{n-k} \geq \sigma'_1 - k.$$

Therefore, we can apply Proposition 7.4. We get that

$$[s_{\sigma}(x)]s_{\lambda/d/\mu}(x) = [s_{\sigma}(x)] \sum_{\substack{\tau, e \\ \tau \subseteq k \times (n-k)}} c_{\tau,e} s_{\tau/e+1/\emptyset}(x), \quad (7.5)$$

where

$$s_{\lambda/(d-1)/\mu}(x) = \sum_{\substack{\tau, e \\ \tau \subseteq k \times (n-k)}} c_{\tau,e} s_{\tau/e/\emptyset}(x).$$

By the induction hypothesis, $c_{\tau,e} \geq 0$ for all τ, e . Since σ has n -core ν , we know from Theorem 6.5 that $s_{\sigma}(x)$ appears with coefficient $\varepsilon(\sigma/\nu) = 1$ in $s_{\nu/m/\emptyset}(x)$ and appears with coefficient 0 in the Schur expansion of any other cylindric Schur function. Therefore, (7.5) tells us that $a_{\nu,m} = c_{\nu,m-1} \geq 0$, as required. \square

REFERENCES

- [1] Edward A. Bender and Donald E. Knuth. Enumeration of plane partitions. *J. Combinatorial Theory Ser. A*, 13:40–54, 1972.
- [2] Aaron Bertram, Ionuț Ciocan-Fontanine, and William Fulton. Quantum multiplication of Schur polynomials. *J. Algebra*, 219(2):728–746, 1999.
- [3] Anders S. Buch. Littlewood-Richardson calculator, 1999. Available from <http://home.imf.au.dk/abuch/lrca1c/>.
- [4] C. J. Cummins. $su(n)$ and $sp(2n)$ WZW fusion rules. *J. Phys. A*, 24(2):391–400, 1991.
- [5] Ladnor Geissinger. Hopf algebras of symmetric functions and class functions. In *Combinatoire et représentation du groupe symétrique (Actes Table Ronde C.N.R.S., Univ. Louis-Pasteur Strasbourg, Strasbourg, 1976)*, pages 168–181. Lecture Notes in Math., Vol. 579. Springer, Berlin, 1977.
- [6] Ira M. Gessel. Multipartite P -partitions and inner products of skew Schur functions. In *Combinatorics and algebra (Boulder, Colo., 1983)*, volume 34 of *Contemp. Math.*, pages 289–317. Amer. Math. Soc., Providence, RI, 1984.
- [7] Ira M. Gessel and Christian Krattenthaler. Cylindric partitions. *Trans. Amer. Math. Soc.*, 349(2):429–479, 1997.
- [8] Frederick M. Goodman and Hans Wenzl. Littlewood-Richardson coefficients for Hecke algebras at roots of unity. *Adv. Math.*, 82(2):244–265, 1990.
- [9] Victor G. Kac. *Infinite-dimensional Lie algebras*. Cambridge University Press, Cambridge, third edition, 1990.

- [10] I. G. Macdonald. *Symmetric functions and Hall polynomials*. Oxford Mathematical Monographs. The Clarendon Press Oxford University Press, New York, second edition, 1995.
- [11] Claudia Malvenuto. P -partitions and the plactic congruence. *Graphs Combin.*, 9(1):63–73, 1993.
- [12] Claudia Malvenuto. *Produits et coproduits des fonctions quasi-symétriques et de l'algèbre des descentes*, volume 16 of *Publications du Laboratoire de Combinatoire et d'Informatique Mathématique*. Laboratoire de Combinatoire et d'Informatique Mathématique, Université du Québec à Montréal, 1993. Ph.D. thesis.
- [13] Claudia Malvenuto and Christophe Reutenauer. Duality between quasi-symmetric functions and the Solomon descent algebra. *J. Algebra*, 177(3):967–982, 1995.
- [14] Peter McNamara. *Edge labellings of partially ordered sets*. PhD thesis, Massachusetts Institute of Technology, 2003. <http://www.lacim.uqam.ca/~mcnamara/research.html>.
- [15] Alexander Postnikov. Affine approach to quantum Schubert calculus. *Duke Math. J.*, to appear. <http://www.arxiv.org/abs/math.CO/0205165>.
- [16] Richard P. Stanley. *Ordered structures and partitions*. American Mathematical Society, Providence, R.I., 1972. Memoirs of the American Mathematical Society, No. 119.
- [17] Richard P. Stanley. *Enumerative combinatorics. Vol. I*. Wadsworth & Brooks/Cole Advanced Books & Software, Monterey, CA, 1986. Second printing, Cambridge University Press, Cambridge/New York, 1997.
- [18] Richard P. Stanley. Errata and addenda to *Enumerative combinatorics. Vol. 1, second printing*. <http://www-math.mit.edu/~rstan/ec/newerr.ps>, version of 9th April 2003 or later.
- [19] Richard P. Stanley. *Enumerative combinatorics. Vol. 2*, volume 62 of *Cambridge Studies in Advanced Mathematics*. Cambridge University Press, Cambridge, 1999.
- [20] Richard P. Stanley. Recent developments in algebraic combinatorics. *Israel J. Math.*, 143:317–339, 2004.
- [21] John R. Stembridge. SF, posets and coxeter/weyl. Available from <http://www.math.lsa.umich.edu/~jrs/maple.html>.
- [22] Jean-Yves Thibon. Coproduits de fonctions symétriques. *C. R. Acad. Sci. Paris Sér. I Math.*, 312(8):553–556, 1991.
- [23] Mark A. Walton. Fusion rules in Wess-Zumino-Witten models. *Nuclear Phys. B*, 340(2-3):777–790, 1990.
- [24] Andrey V. Zelevinsky. *Representations of finite classical groups*, volume 869 of *Lecture Notes in Mathematics*. Springer-Verlag, Berlin, 1981. A Hopf algebra approach.

LABORATOIRE DE COMBINATOIRE ET D'INFORMATIQUE MATHÉMATIQUE, UNIVERSITÉ DU QUÉBEC À MONTRÉAL, CASE POSTALE 8888, SUCCURSALE CENTRE-VILLE, MONTRÉAL (QUÉBEC) H3C 3P8, CANADA.

Current address: INSTITUTE SUPERIOR TÉCNICO, DEPARTAMENTO DE MATEMÁTICA, AV. ROVISCO PAIS, 1049-001 LISBOA, PORTUGAL.

E-mail address: mcnamara@lacim.uqam.ca